

Acer

**Aspire X1935
Service Guide**

PRINTED IN TAIWAN

Revision History

Please refer to the table below for the updates made on this service guide.

Date	Chapter	Updates

Copyright

Copyright © 2012 by Acer Incorporated. All rights reserved. No part of this publication may be reproduced, transmitted, transcribed, stored in a retrieval system, or translated into any language or computer language, in any form or by any means, electronic, mechanical, magnetic, optical, chemical, manual or otherwise, without the prior written permission of Acer Incorporated.

Disclaimer

The information in this guide is subject to change without notice.

Acer Incorporated makes no representations or warranties, either expressed or implied, with respect to the contents hereof and specifically disclaims any warranties of merchantability or fitness for any particular purpose. Any Acer Incorporated software described in this manual is sold or licensed "as is". Should the programs prove defective following their purchase, the buyer (and not Acer Incorporated, its distributor, or its dealer) assumes the entire cost of all necessary servicing, repair, and any incidental or consequential damages resulting from any defect in the software.

Acer is a registered trademark of Acer Corporation.

Intel is a registered trademark of Intel Corporation.

Pentium Dual-Core, Celeron Dual-Core, Core 2 Duo, Core 2 Quad, Celeron, and combinations thereof, are trademarks of Intel Corporation.

Other brand and product names are trademarks and/or registered trademarks of their respective holders.

Conventions

The following conventions are used in this manual:

SCREEN MESSAGES	Denotes actual messages that appear on screen.
NOTE	Gives additional information related to the current topic.
WARNING	Alerts you to any physical risk or system damage that might result from doing or not doing specific actions.
CAUTION	Gives precautionary measures to avoid possible hardware or software problems.
IMPORTANT	Reminds you to do specific actions relevant to the accomplishment of procedures.

Service Guide Coverage

This Service Guide provides you with all technical information relating to the BASIC CONFIGURATION decided for Acer's "global" product offering. To better fit local market requirements and enhance product competitiveness, your regional office MAY have decided to extend the functionality of a machine (e.g. add-on card, modem, or extra memory capability). These LOCALIZED FEATURES will NOT be covered in this generic service guide. In such cases, please contact your regional offices or the responsible personnel/channel to provide you with further technical details.

FRU Information

Please note WHEN ORDERING FRU PARTS, that you should check the most up-to-date information available on your regional web or channel. If, for whatever reason, a part number change is made, it will not be noted in the printed Service Guide. For ACER-AUTHORIZED SERVICE PROVIDERS, your Acer office may have a DIFFERENT part number code to those given in the FRU list of this printed Service Guide. You MUST use the list provided by your regional Acer office to order FRU parts for repair and service of customer machines.

Table of Contents

System Tour	1
Features	1
Block Diagram	5
System Components	6
Front Panel	6
Rear Panel	7
Hardware Specifications and Configurations	8
Power Management Function(ACPI support function)	12
System Utilities	13
CMOS Setup Utility	13
Entering CMOS setup	14
Navigating Through the Setup Utility	14
Setup Utility Menus	15
Main	15
System Disassembly and Assembly	25
Disassembly Requirements	25
Pre-disassembly Procedure	26
Removing the Side Panel	27
Removing the Front Bezel	28
Removing the Heat Sink Fan Assembly	29
Removing the Processor	31
Removing the HDD-ODD Bracket	33
Removing the Optical Drive and Hard Disk Drive	34
Detaching the Front Bezel	38
Removing the Memory Modules	39
Removing the Power Supply	40
Removing the Front I/O and Optional Card Reader Assembly	42
Removing the Mainboard	45
Assembly Requirements	47
Assembly Procedure	48
Removing the Side Panel	49
Removing the Front Bezel	50
Removing the HDD-ODD Bracket	51
Reinstalling the I/O Shielding	52
Reinstalling the Main Board	53
Reinstalling the Power Supply	55
Reinstalling the Memory	57
Reinstalling the Front Bezel Power Button/LED Cable	58
Reinstalling the Optical Drive and Hard Disk Drive	59
Reinstalling the HDD-ODD Bracket	63
Reinstalling the Processor	64
Reinstalling the Heat Sink Fan Assembly	66
Reinstalling the Front Bezel	68
Reinstalling the Side Panel	69
System Troubleshooting	70
Hardware Diagnostic Procedure	70
System Check Procedures	71
Power System Check	71
System External Inspection	71

System Internal Inspection	71
Beep Codes	72
Checkpoints	73
BIOS Recovery	76
Jumper and Connector Information	77
M/B Placement	77
Jumper Setting	79
Internal Header Pin Definition	80
Connector Pin Definition	83
FRU (Field Replaceable Unit) List	86
Aspire X19350 Exploded Diagram	87
Aspire X1935 FRU List	88

System Tour

Features

Below is a brief summary of the computer's many feature:

NOTE: The features listed in this section is for your reference only. The exact configuration of the system depends on the model purchased.

Operating System

- Microsoft Windows 7 Home Premium x64
- Microsoft Windows 7 Home Basic x64
- Linpus XWindows
- Free DOS

Processor

- Intel Ivy Bridge / Sandy Bridge Processor.
- Socket type: LGA1155.
- FMB: 65W / 95W.

VRD power

- Dual Output 4 (3+4) phase + 1 Phase PWM design.
 - 2 *High side MOS + 2 * Low side MOS.
 - Heatsink hole is reserved for MOS.

Chipset

- PCH: Intel B75

PCB

- DTX, max 4 Layers

Memory subsystem

- Socket Type: DDR III connector.
- Socket Quantity: 4 DIMMs.
- 2 channels, 2 DIMMs per channel. Different colors for DIMM 0 and DIMM 1.
- Dual channel should be enabled always when plug-in 2 same memory size DDRIII. memory module.
- Max memory of 16 GB supported (using 4Gb tech).
- Support DDR3 1.5V 1333/1600(1GB / 2GB / 4GB).

Graphics

- Intel® HD Graphics Support (supported by CPU).
 - Dual independent display on HDMI and VGA.
 - DVMT 5.0 technology support.
 - Enhanced 3D and Clear Video technology support.
 - Need to measure VGA follow Acer VGA SOP.
- Monitor compatible is requested to the monitor AVL and DQM recommended list.

Hard disk drive

- Support up to one SATA ports. 3.5
- Capacity and models are listed on AVLC

Optical disk drive

- Support up to one SATA 5.25" standard ODD.
- Support DVD-ROM, DVD-SuperMulti, BD-combo.
- Maximum ODD depth to 185mm with bezel.
- Models are listed on AVLC.

Graphics card

- No mechanical restriction to support single slot graphics cards in the PCIe X16 slot.

SUPER IO

- Support PECI 3.0 and detect VRD/CPU/System temperature.
- ITE 8772E or other solution proposed by MB vender.

Audio

- Realtek ALC662VD.
- Rear IO: 3 jack.
- Front IO: 1*Microphone-in, 1*head phone jack.

Serial ATA controller

- SATA * 3 (different color to identify SATA 6Gb/s and SATA 3Gb/s)
- B75: 1 SATA 6 Gb/s header.
- HDD : Support AHCI/Native IDE.
 - Support Intel® Smart Response Technology.
- ODD: Support BD/SuperMulti/DVD ROM.

LAN

- Intel 82579V

Extension slot

- 1 * PCIE x16 (PCIE V3.0)
- 1 * PCIE x1 (PCIE V2.0)

USB Ports

- USB2.0:
 - Rear IO : * 4 ports
 - Internal Header:
 - *4 ports (2 * USB2.0 H5X2 Header) for B75
 - - All ports should meet USB IF spec and support 1A current over drive.
- USB3.0:
 - Internal Header: * 2 ports.
 - One port support USB fast charging. (Meet USB battery charging spec. ver. 1.2. , Apple charging including ipad.) The other port support standard USB 3.0 downstream port.
 - Support fast charging in S0, S3, S4, S5, G3 to S5.
 - All ports should meet USB IF spec and support 2A capability for each port (S0).
 - reserve design for two USB 3.0 standard down stream ports.
 - Internal USB 3.0 H10x2 connector, follow the Industrial standard
 - H2x1 with Vbus which is required to provide 3A current to front daughter board
 - Charging IC is required for fast charger. (ODM proposed)
 - Rear IO: * 2 ports.
 - All ports should meet USB IF spec and support 2A capability for each port (S0).

Buzzer

- 1 on board buzzer.

Rear I/O connectors

- 1 * PS2 KB+MS
- 1 * VGA connector
- 1 * HDMI
- 1 * RJ45 + Dual USB2.0
- 1 * Dual USB2.0 connector
- 2 * USB 3.0 stack
- 1 * 3 ports Audio jack

On-board connectors

- 1 * ILM(Independent Loading Mechanism) for LGA 1155 CPU (assign by Acer).
- 1 * 24-pin ATX PWR connector.
- 1 * H2X4 Power Supply Connector.
- 4 * DDR3 DIMM Socket.
- 2 * SATA 3Gb/s.
- 1 * SATA 6Gb/s.
- 2 * USB2.0 H5X2 Header (support 4 ports).
- 1 * USB 3.0 H10x2 Header (support 2 ports).
- 1 * H2x1 for Vbus.
- 1 * Front Audio Pannel H5X2 header.
- 1 * Front Panel IO H7X2 Header for Acer pin define.
- 1 * H1X4 CPU with SAMRT FAN controller.
- 1 * H1X4 System with SAMRT FAN controller (co-lay with 3 pin FAN control).

-
- 1 * H3X1 Clear CMOS Header (with jumper).
 - 1 * onboard Buzzer.
 - 2 * H1X2 GPIO header.
 - 1 * H10X2 TPM header.
 - 1 * 3pin ME enable / disable connector(Jumper).

System BIOS

- Type:
 - Use SPI Flash.
 - ME Size: /5MBytes (For B75).
 - System BIOS: 8MBytes (For B75).
- Kernel:
 - AMI Kernel with Acer skin.

Power supply

- Non PFC 220W / PFC 220W / Active PFC 220W.
- Support models are listed on AVLC.

Block Diagram

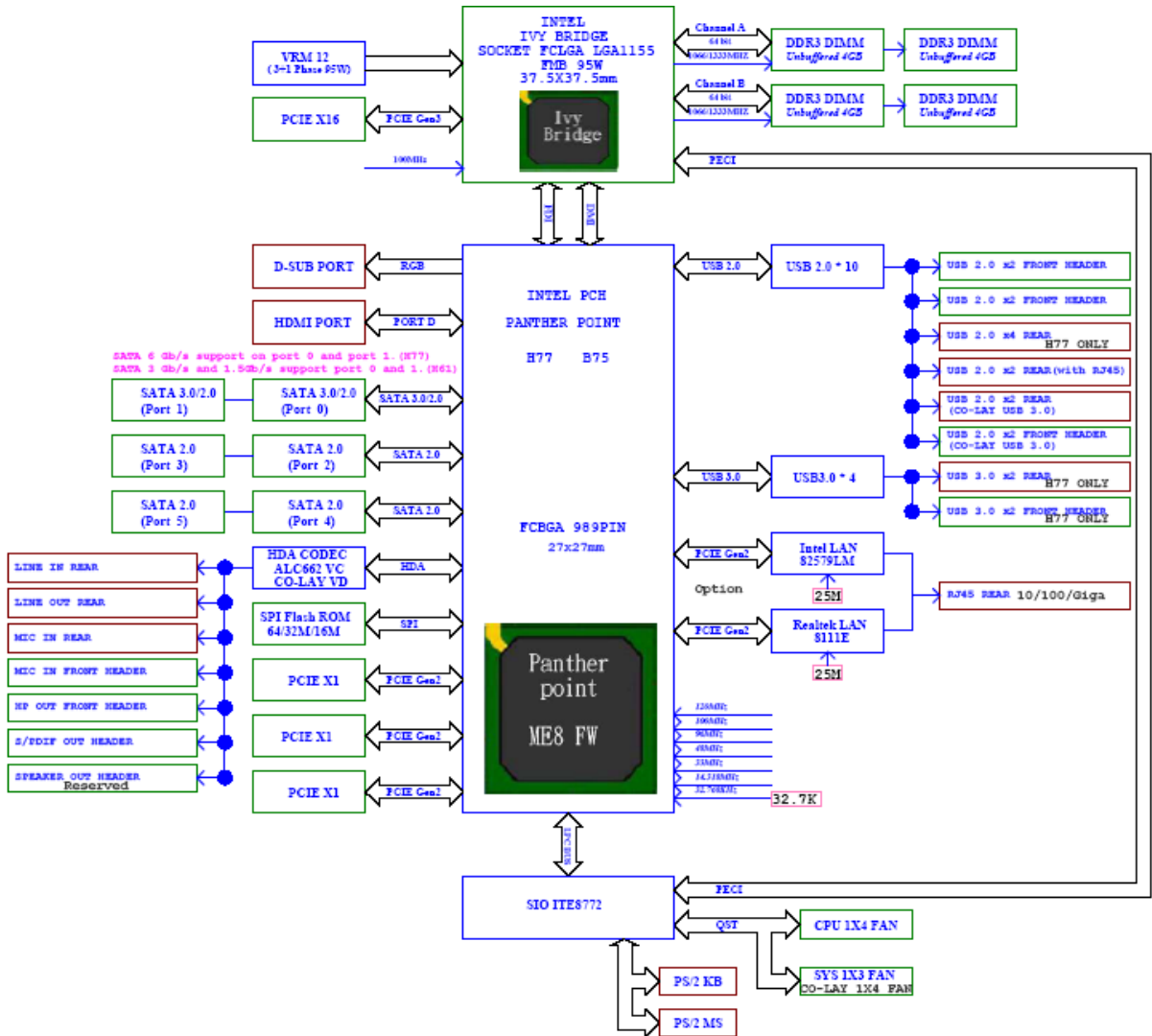

System Components

This section is a virtual tour of the system's interior and exterior components.

Front Panel



No.	Component
1	Power button/indicator
2	Optical drive cover
3	Optical drive eject button
4	Headphone jack
5	Microphone-in jack
6	4-in-1 optional card reader supporting Memory Stick (MS), xD-Picture Card (xD), Secure Digital (SD), MultiMediaCard (MMC) and Memory Stick PRO (MS PRO)
7	USB 2.0 ports
8	Acer logo

Rear Panel

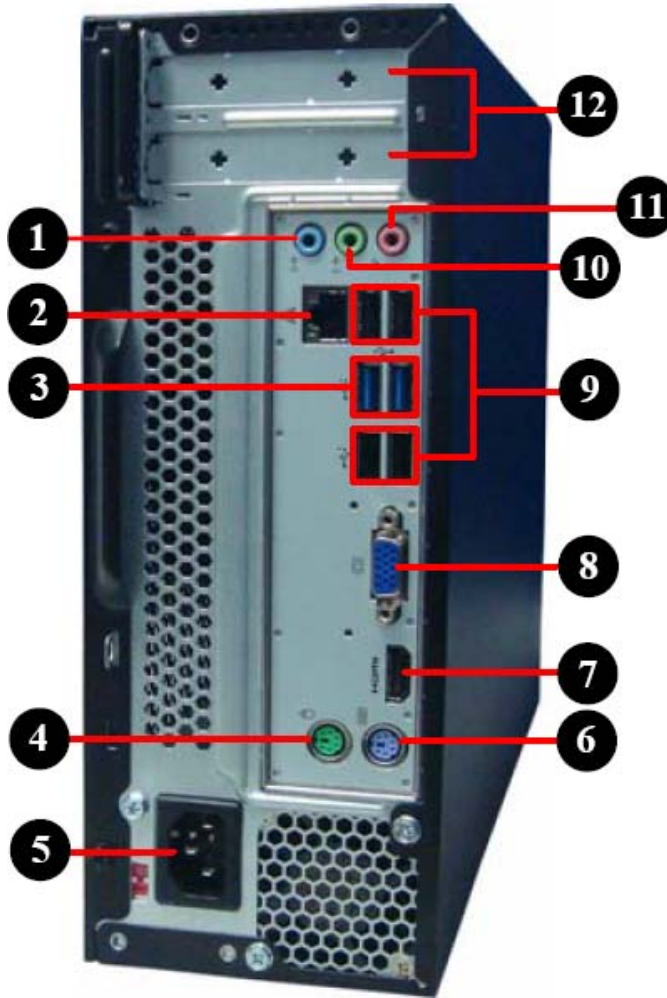

No.	Component
1	Line-in jack
2	RJ45 LAN connector
3	USB 3.0 ports
4	PS2 mouse port
5	Power connector
6	PS2 keyboard port
7	HDMI port
8	D-sub port
9	USB 2.0 ports
10	Line-out jack
11	Microphone jack
12	Expansion slot

Hardware Specifications and Configurations

Processor

Item	Specification
Processor Type	Intel Ivy Bridge / Sandy Bridge Processor
Socket Type	LGA1155
Minimum operating speed	0 MHz (If Stop CPU Clock in Sleep State in BIOS Setup is set to Enabled.)

BIOS

Item	Specification
BIOS code programmer	AMI Kernel with Acer skin
BIOS version	P01-A0
BIOS ROM type	SPI Flash
BIOS ROM size	64Mb
Support protocol	SMBIOS(DMI)2.7
Device Boot Support	1st priority: SATA HDD 2nd priority: CD-ROM 3rd priority: Removable Device 4th priority: LAN 5th priority: USB device
Support to LS-120 drive	No
Support to BIOS boot block feature	YES

BIOS Hotkey List

Hotkey	Function	Description
Del	Enter BIOS Setup Utility	Press while the system is booting to enter BIOS Setup Utility.

Main Board Major Chips

Item	Specification
Chipset	Intel B75
USB controller	Intel B75
Audio controller	Intel B75+ALC662-VD
LAN controller	Intel 82579V
SATA controller	Intel B75
Super IO controller	ITE 8772F

Memory Combinations

Slot	Memory	Total Memory
Slot 1	1GB,2GB,4GB	1G ~4GB
Slot 2	1GB,2GB,4GB	1G ~4GB
Slot 3	1GB,2GB,4GB	1G ~4GB
Slot 4	1GB,2GB,4GB	1G ~4GB
Maximum System Memory Supported		1G~16GB

System Memory

Item	Specification
Memory slot number	4 slot
Support Memory size per socket	1GB/2GB/4GB
Support memory type	DDRIII
Support memory interface	DDRIII 1333/1600MHz
Support memory voltage	1.5V
Support memory module package	240-pin DDRIII
Support to parity check feature	Yes
Support to error correction code (ECC) feature	No
Memory module combinations	You can install memory modules in any combination as long as they match the above specifications.

Audio Interface

Item	Specification
Audio controller	Intel PCH B75
Audio controller type	ALC662-VD
Audio channel	codec 5.1
Audio function control	Enable/disable by BIOS Setup
Mono or stereo	Stereo
Compatibility	The ALC662-VD supports host audio from Intel chipsets, and also from any other HDA compatible audio controller. With EAX/Direct Sound 3D/I3DL2 compatibility, software utilities like Karaoke mode, environment emulation, multi-band software equalizer, 3D positional audio, and optional Dolby R Digital Live and DTS R CONNECT™ programs, the ALC662-VD provides an excellent home entertainment package and game experience for PC users.
Music synthesizer	No
Sampling rate	192 kHz (max.)
MPU-401 UART support	No
Microphone&Headphone jack	Supported

SATA Interface

Item	Specification
SATA controller	Intel B75
Number of SATA channel	SATA X 3(2 * SATA 3Gb/s, 1 * SATA 6Gb/s)
Support mode	AHCI/IDE mode option

USB Port

Item	Specification
Universal HCI	USB 2.0/1.1 or USB 3.0
USB Class	Support legacy keyboard for legacy mode
USB Connectors Quantity	<p>USB2.0:</p> <ul style="list-style-type: none"> Rear IO : * 4 ports Internal Header: *4 ports (2 * USB2.0 H5X2 Header) for B75 All ports should meet USB IF spec and support 1A current over drive. <p>USB3.0:</p> <p>Internal Header: * 2 ports.</p> <ul style="list-style-type: none"> One port support USB fast charging.(Meet USB battery charging spec. ver. 1.2. , Apple charging including ipad.) The other port support standard USB 3.0 downstream port. Support fast charging in S0, S3, S4, S5, G3 to S5. All ports should meet USB IF spec and support 2A capability for each port (S0). reserve design for two USB 3.0 standard down stream ports. Internal USB 3.0 H10x2 connector, follow the Industrial standard. H2x1 with Vbus which is required to provide 3A current to front daughter board. Charging IC is required for fast charger. (ODM proposed) Rear IO: * 2 ports. All ports should meet USB IF spec and support 2A capability for each port (S0).

Environmental Requirements

Item	Specification
Temperature	
Operating	+5°C ~ +35°C
Non-operating	-20 ~ +60°C (Storage package)
Humidity	
Operating	15% to 80% RH
Non-operating	10% to 90% RH
Vibration	
Operating (unpacked)	5 ~ 500 Hz: 2.20g RMS random, 10 minutes per axis in all 3 axes. 5 ~500 Hz: 1.09g RMS random, 1 hour per axis in all 3 axes.

Power Management

Devices	S1	S3	S4	S5
Power Button	V	V	V	V
USB Keyboard/Mouse	V	V	N/A	N/A
PME	Disabled	Disabled	Disabled	Disabled
RCT	Disabled	Disabled	Disabled	Disabled
WOR	Disabled	Disabled	Disabled	Disabled

- Devices wake up from S3 should be less than.
- Devices wake up from S5 should be less than 10 seconds.

Power Management Function(ACPI support function)

Device Standby Mode

- Independent power management timer for hard disk drive devices(0-15 minutes,time step=1minute).
- Hard Disk drive goes into Standby mode(for ATA standard interface).
- Disable V-sync to control the VESA DPMS monitor.
- Resume method:device activated (keyboard for DOS, keyboard &mouse for Windows).
- Resume recovery time 3-5sec

Global Standby Mode

- Global power management timer(2-120minutes,time step=10minute).
- Hard disk drive goes into Standby mode(for ATA standard interface).
- Disable H-sync and V-sync signals to control the VESA DPMS monitor.
- Resume method: Resume to original state by pushing external switch Button,modem ring in,keyboard an mouse for APM mode.
- Resume recovery time :7-10sec

Suspend Mode

- Independent power management timer(2-120minutes,time step=10minute)or pushing extern switch button.
- CPU goes into SMM
- CPU asserts STPCLK# and goes into the Stop Grant State.
- LED on panel turns amber colour.
- Hard disk drive goes into SLEEP mode (for ATA standard interface).
- Disable H-sync and V-sync signals to control the VESA DPMS monitor.
- Ultra I/O and VGA chip go into power saving mode.
- Resume method: Resume to original state by pushing external switch Button,modem ring in,keyboard an mouse for APM mode
- Return to original state by pushing external switch button,modem ring in and USB keyboard for ACPI mode.

ACPI

- ACPI specification 1.0b
- S0,S1,S2 and S5 sleep state support.
- On board device power management support.
- On board device configuration support.

System Utilities

CMOS Setup Utility

CMOS setup is a hardware configuration program built into the system ROM, called the complementary metal-oxide semiconductor (CMOS) Setup Utility. Since most systems are already properly configured and optimized, there is no need to run this utility. You will need to run this utility under the following conditions.

- When changing the system configuration settings
- When redefining the communication ports to prevent any conflicts
- When modifying the power management configuration
- When changing the password or making other changes to the security setup
- When a configuration error is detected by the system and you are prompted ("Run Setup" message) to make changes to the CMOS setup

NOTE: If you repeatedly receive Run Setup messages, the battery may be bad. In this case, the system cannot retain configuration values in CMOS. Ask a qualified technician for assistance.

CMOS setup loads the configuration values in a battery-backed nonvolatile memory called CMOS RAM. This memory area is not part of the system RAM which allows configuration data to be retained when power is turned off.

Before you run the *CMOS Setup Utility*, make sure that you have saved all open files. The system reboots immediately after you close the Setup.

NOTE: *CMOS Setup Utility* will be simply referred to as "BIOS", "Setup", or "Setup utility" in this guide.

The screenshots used in this guide display default system values. These values may not be the same those found in your system.

Entering CMOS setup

1. Turn on the server and the monitor.

If the server is already turned on, close all open applications, then restart the server.

2. During POST, press **Delete**.

If you fail to press **Delete** before POST is completed, you will need to restart the server.

The Setup Main menu will be displayed showing the Setup's menu bar. Use the left and right arrow keys to move between selections on the menu bar.

Navigating Through the Setup Utility

Use the following keys to move around the Setup utility.

- **Left** and **Right** arrow keys – Move between selections on the menu bar.
- **Up** and **Down** arrow keys – Move the cursor to the field you want.
- **PgUp** and **PgDn** keys – Move the cursor to the previous and next page of a multiple page menu.
- **Home** – Move the cursor to the first page of a multiple page menu.
- **End** – Move the cursor to the last page of a multiple page menu.
- **+** and **-** keys – Select a value for the currently selected field (only if it is user-configurable). Press these keys repeatedly to display each possible entry, or the **Enter** key to choose from a pop-up menu.

NOTE: Grayed-out fields are not user-configurable.

- **Enter** key – Display a submenu screen.

NOTE: Availability of submenu screen is indicated by a (>).

- **Esc** – If you press this key:
 - On one of the primary menu screens, the Exit menu displays.
 - On a submenu screen, the previous screen displays.
 - When you are making selections from a pop-up menu, closes the pop-up without making a selection.
- **F1** – Display the General Help panel.
- **F6** – Press to load optimized default system values.
- **F7** – Press to load fail-safe default system values.
- **F10** – Save changes made the Setup and close the utility.

Setup Utility Menus

Main

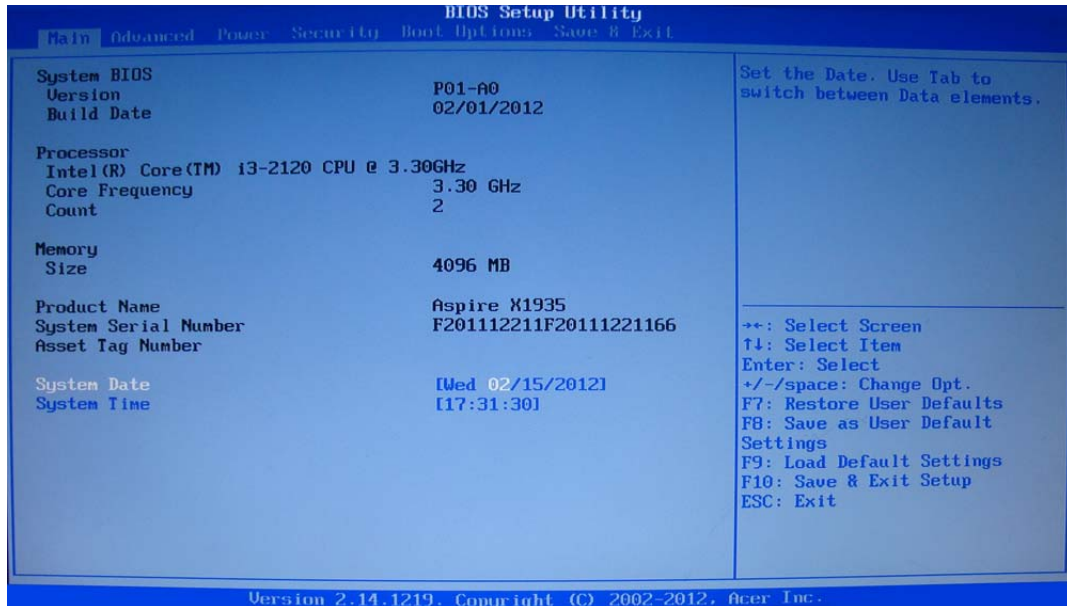

The Setup Main menu includes the following main setup categories.

Parameter	Description
System BIOS	
Version	Version number of the BIOS setup utility.
Build Date	Date when the BIOS setup utility was built
Processor	
Core Frequency	Core speed of the CPU installed on the system.
Count	Physical CPU count
Memory	
Size	Total size of system memory installed on the system.
Product Name	Product name of the system.
System Serial Number	Serial number of the system.
Asset Tag Number	Asset tag number of this system.
System Date	Set the date following the weekday-month-day-year format.
System Time (hh:mm:ss)	Set the system time following the hour-minute-second format.

In the descriptive table following each of the menu screenshots, settings in **boldface** are the default and suggested settings.

Advanced

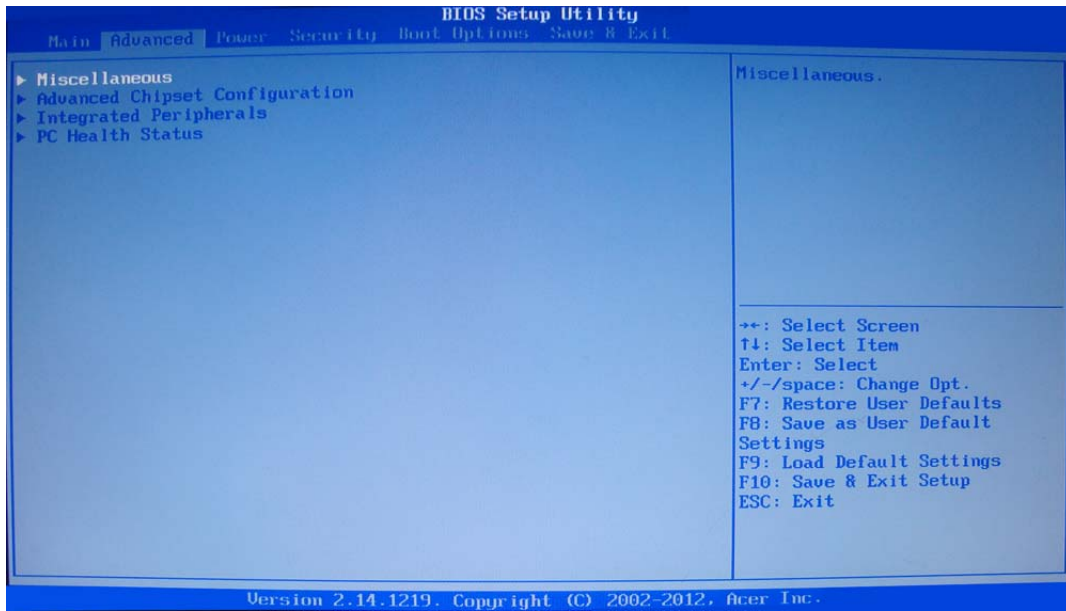

Parameter	Description
Miscellaneous	Press Enter to access the Miscellaneous submenu
Advanced Chipset Configuration	Press Enter to access the Advanced Chipset Configuration submenu
Integrated Peripherals	Press Enter to access the Integrated Peripherals submenu
PC Health Status	Press Enter to access the PC Health Status submenu

Miscellaneous

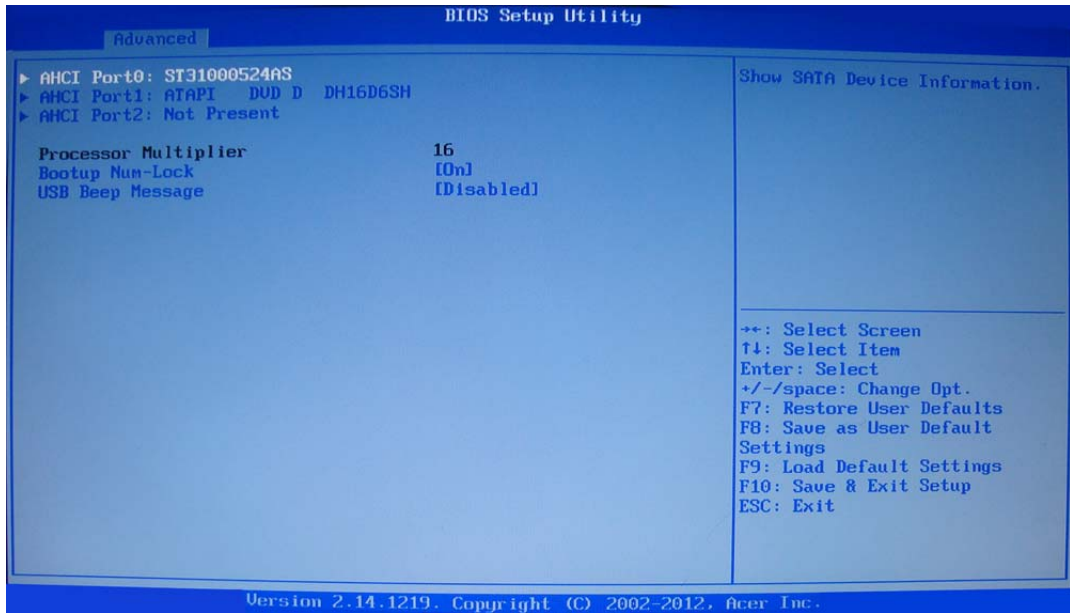

Parameter	Description	Option
AHCI Port0/1/2	Displays the status of auto detection of the AHCI device.	
Bootup Num-lock	Selects power on state for Num Lock.	On Off
USB Beep Message	Enables or disables BIOS to display error beeps or messages during USB device enumeration.	Enabled Disabled

Advanced Chipset Configuration

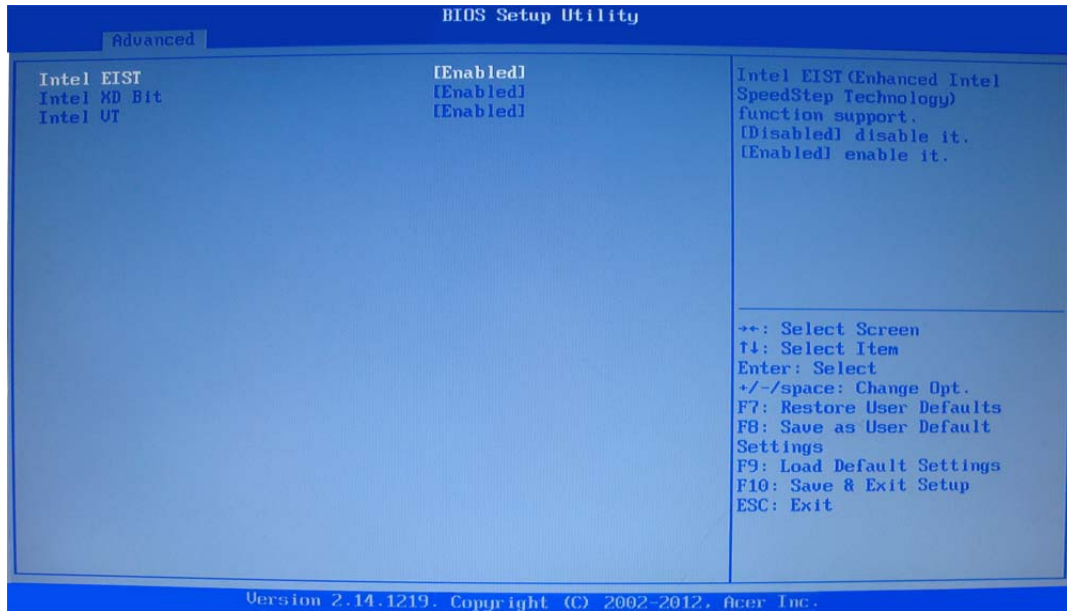

Intel EIST	When enabled, this feature allows the OS to reduce power consumption. When disabled, the system operates at maximum CPU speed.	Enabled Disabled
Intel XD Bit	When enabled, the processor disables code execution when a worm attempts to insert a code in the buffer preventing damage and worm propagation. When disabled, the processor forces the Execute Disable (XD) Bit feature flag to always return to 0.	Enabled Disabled
Intel VT	Enables or disables the Virtualization Technology (VT) availability. If enabled, a virtual machine manager (VMM) can utilize the additional hardware virtualization capabilities provided by this technology. Note: A full reset is required to change the setting.	Enabled Disabled

Integrated Peripherals

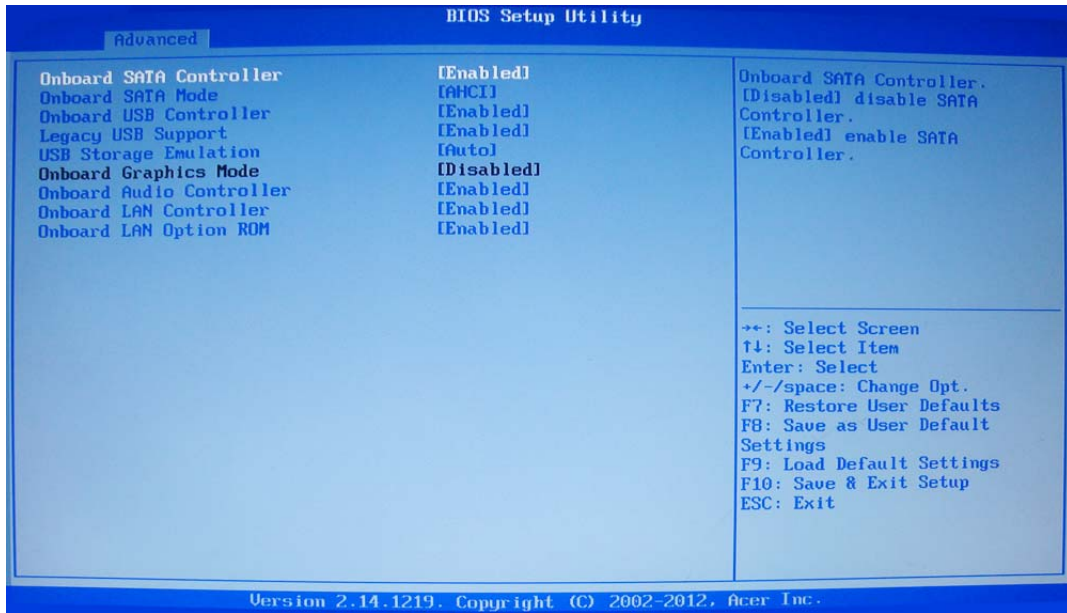

Parameter	Description	Option
Onboard SATA Controller	Enables or disables the onboard SATA controller.	Enabled Disabled
Onboard SATA Mode	Select an operating mode for the onboard SATA.	Native IDE AHCI
Onboard USB Controller	Enables or disables the onboard USB controller.	Enabled Disabled
Legacy USB Support	Enables or disables support for legacy USB devices.	Enabled Disabled
USB Storage Emulation	If Auto, USB device equal or less than 2GB will be emulated as Floppy and remaining as harddrive. Forced FDD option can be used to force a HDD formatted drive to boot as FDD (Ex.ZIP drive).	Auto Floppy Hard Disk
Onboard Graphics Controller	Enables or disables the onboard Graphics Controller.	Enabled Disabled
Onboard Audio Controller	Enables or disables the onboard audio controller.	Enabled Disabled
Onboard LAN Controller	Enables or disables the onboard LAN controller.	Enabled Disabled
Onboard LAN Option ROM	Enables or disables the load of embedded option ROM for onboard network controller.	Enabled Disabled

PC Health Status

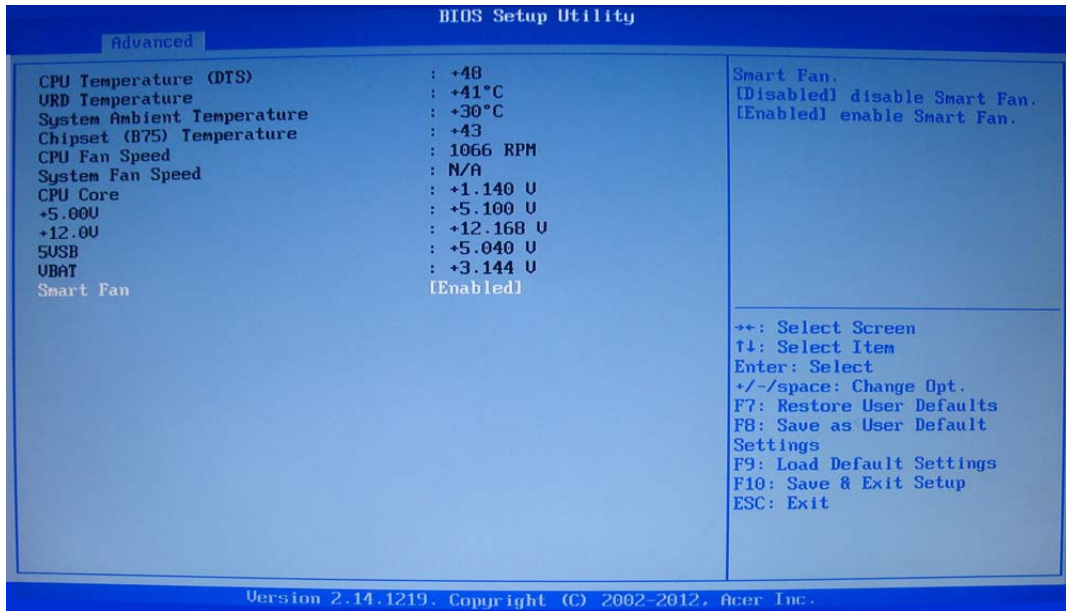

Parameter	Description	Option
Smart Fan	Enables or disables the smart system fan control function.	Enabled Disabled

Power

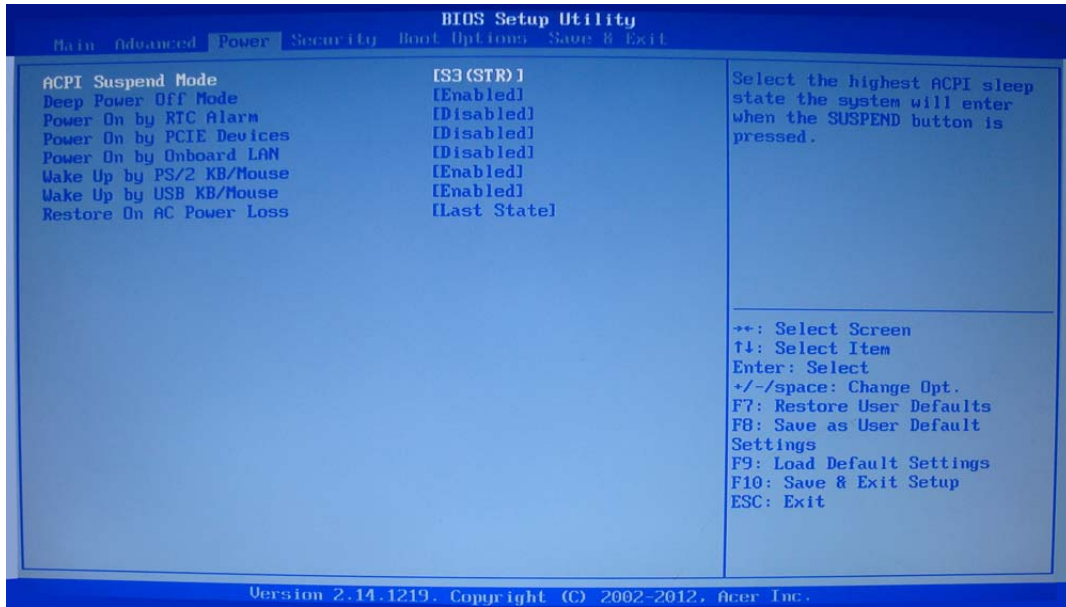

Parameter	Description	Option
ACPI Suspend Mode	Select an ACPI state.	S3 (STR) S1 (POS)
Deep Power Off Mode	Select the Deep power off Mode	Enabled Disabled
Power On by RTC Alarm	Enables or Disables to wake up the system by RTC Alarm Function	Enabled Disabled
Power On by PCIE Devices	This system can be turned off with a software commend. If you enable this item, the system can automatically resume if there is an incoming call on the PCIE LAN card.You must use an ATX power supply in order to use this feature.Use this item to dowake-up action if inserting the PCIE card.	Enabled Disabled
Power On by Onboard LAN	Enables or disables an onboard LAN controller to generate a wake event.	Enabled Disabled
Wake Up by PS/2 KB/ Mouse	Enables or disables to wake up the system from a power saving mode using a PS2 keyboard or mouse.	Enabled Disabled
Wake Up by USB KB/ Mouse	If enabled, press any key or click the mouse will wake system from S1/ S3 state.	Enabled Disabled
Restore On AC Power Loss	Enables or disables the system to reboot after a power failure or interrupt occurs.	Off On Last State

Security

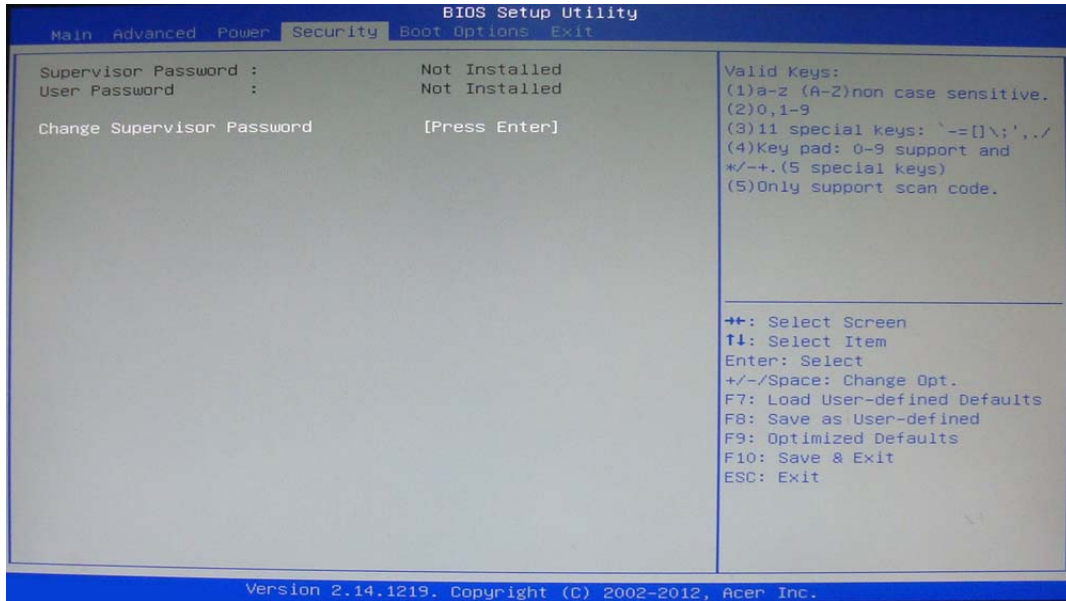

Parameter	Description	Option
Supervisor Password	This item indicates whether a supervisor password has been set. If the password has been installed, Installed displays. If not, Not Installed displays.	
User Password	This item allows you to change user password.	
Change Supervisor Password	You can select this option and press <Enter> to access the sub menu. You can use the sub menu to change the supervisor password.	

Setting a supervisor password

- Use the up/down arrow keys to select Change Supervisor Password menu then press **Enter**.
A password box will appear.
- Type a password then press **Enter**.
The password may consist up to six alphanumeric characters (A-Z, a-z, 0-9)
- Retype the password to verify the first entry then press **Enter** again.
- Press **F10**.
- Select **Yes** to save the new password and close the Setup Utility.

Changing the supervisor password

- Use the up/down arrow keys to select Change Supervisor Password menu then press **Enter**.
- Type the original password then press **Enter**.
- Type a new password then press **Enter**.
- Retype the password to verify the first entry then press **Enter** again.
- Press **F10**.
- Select **Yes** to save the new password and close the Setup Utility.

Removing a supervisor password

- Use the up/down arrow keys to select Change Supervisor Password menu then press **Enter**.
- Enter the current password then press **Enter**.
- Press **Enter** twice without entering anything in the password fields.

Boot Options

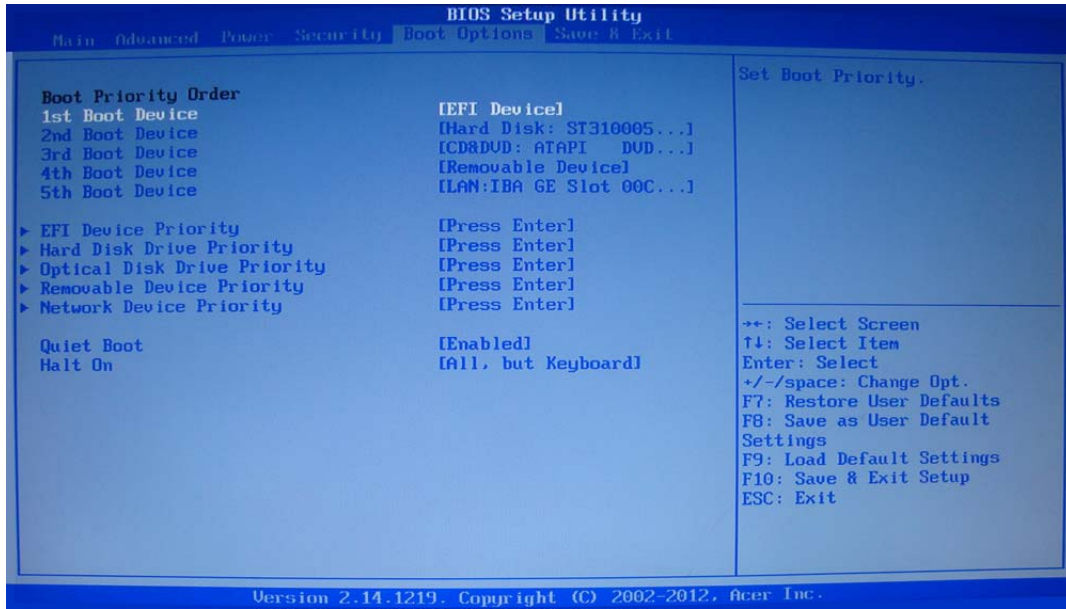

1st/2nd/3rd/4th/5th Boot Device	Specifies the boot order from the available devices.	EFI Hard Disk CD^DVD Removable Device LAN
EFI Device Priority	Press Enter to access the EFI Device Priority submenu and specify the boot device priority sequence from available EFI devices.	
Hard Disk Drive Priority	Press Enter to access the Hard Disk Drive Priority submenu and specify the boot device priority sequence from available hard drives.	
Optical Disk Drive Priority	Press Enter to access the Optical Disk Drive Priority submenu and specify the boot device priority sequence from available optical drives.	
Removable Device Priority	Press Enter to access the Removable Device Priority submenu and specify the boot device priority sequence from available removable drives.	
Network Device Priority	Press Enter to access the Network Device Priority submenu and specify the boot device priority sequence from available network drives.	
Quiet Boot	When enabled, the BIOS splash screen displays during startup. When disabled, the diagnostic screen displays during startup.	Enabled Disabled
Halt On	Determines whether the system will stop for an error during the POST.	All, but keyboard No Errors All Errors

Exit

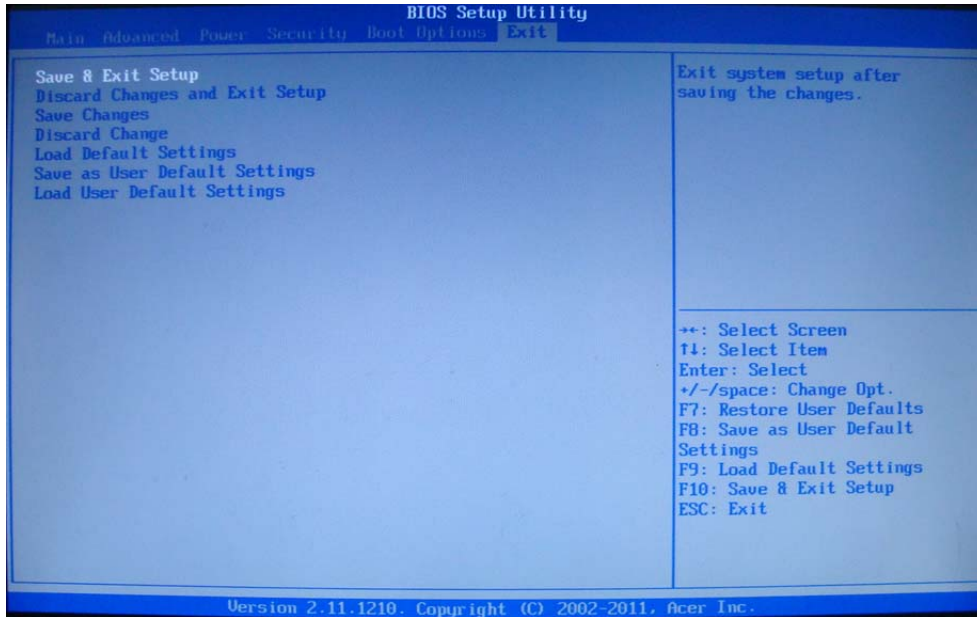

Parameter	Description
Save & Exit Setup	When you have completed the system configuration changes, select this option to leave the BIOS Setup Utility and reboot the computer, so the new system configuration parameters can take effect. Select Save & Exit Setup from the Exit menu and press Enter.
Discard Changes and Exit Setup	Select this option to quit the BIOS Setup Utility without making any permanent changes to the system configuration, and reboot the computer. Select Discard Changes and Exit Setup from the Exit menu and press Enter.
Save Changes	Select this option and press Enter to save all the changes and return to the BIOS Setup Utility.
Discard Changes	Use this item enables you to discard any changes that you have made.
Load Default Settings	To set this feature, select Load Default Settings from the Exit menu and press Enter. Then, select OK to allow the BIOS to automatically load optimal defaults to the BIOS settings. The Optimal settings are designed for maximum system performance, but may not work best for all computer applications.
Save as User Default Settings	Select this option and press Enter to save changes that you have made as user defaults.
Load User Default Settings	Select this option and press Enter to restore user defaults.

System Disassembly and Assembly

This chapter contains step-by-step procedures on how to disassemble and assemble the desktop computer for maintenance and troubleshooting.

Disassembly Requirements

To disassemble the computer, you need the following tools:

- Wrist grounding strap and conductive mat for preventing electrostatic discharge
- Flat-blade screwdriver
- Philips screwdriver
- Hex screwdriver
- Plastic flat-blade screwdriver
- Plastic tweezers

NOTE: The screws for the different components vary in size. During the disassembly process, group the screws with the corresponding components to avoid mismatch when putting back the components.

Pre-disassembly Procedure

Before proceeding with the disassembly procedure, perform the steps listed below:

1. Turn off the system and all the peripherals connected to it.
2. Unplug the power cord from the power outlets.
3. Unplug the power cord from the system.
4. Unplug all peripheral cables from the system.
5. Place the system unit on a flat, stable surface.

Removing the Side Panel

1. Remove the two screws located on the rear edge of the side panel.



2. Slide the panel back about 2.5 cm (1.0 in) to release it from the chassis notches, then detach the panel from the chassis.
3. Put the side panel aside for reinstallation later.

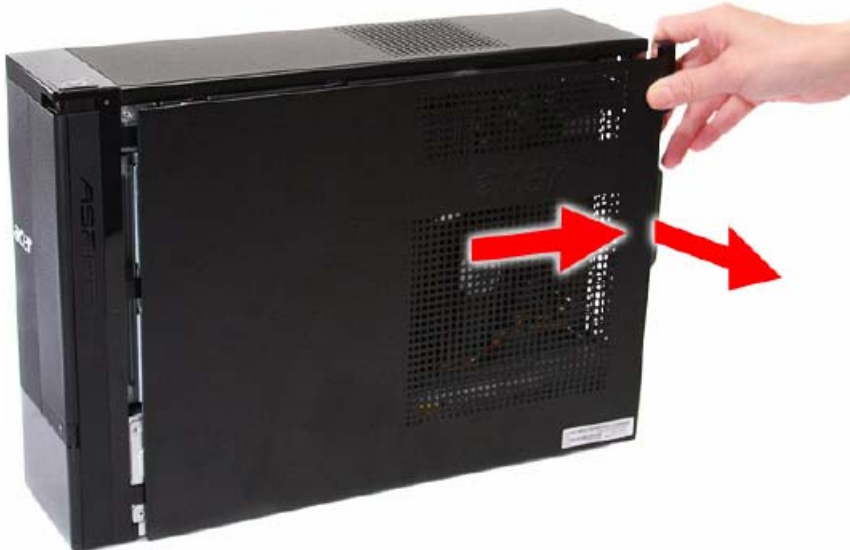

Removing the Front Bezel

1. Release the front bezel retention tabs from the chassis interior.

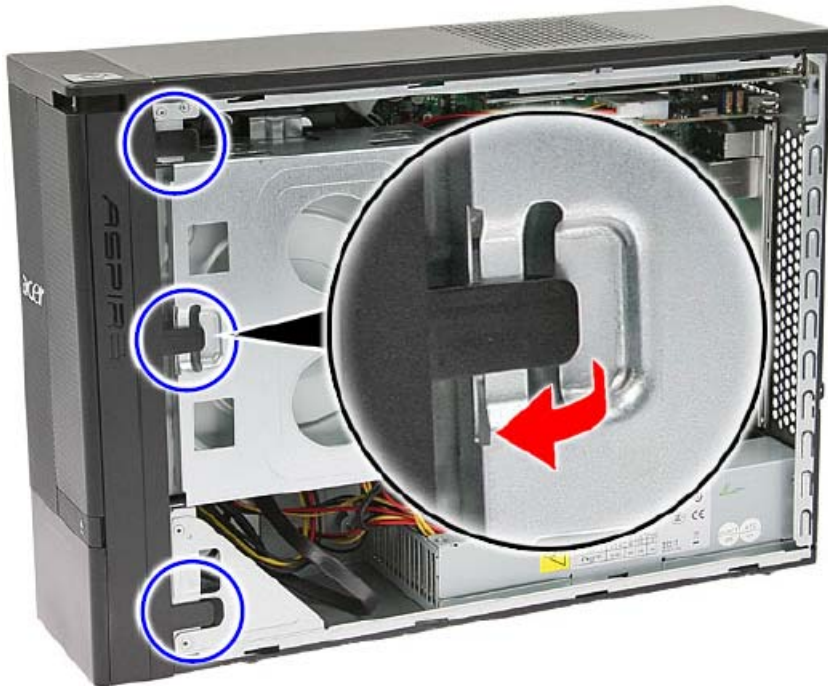

2. Pull the front bezel away from the chassis.

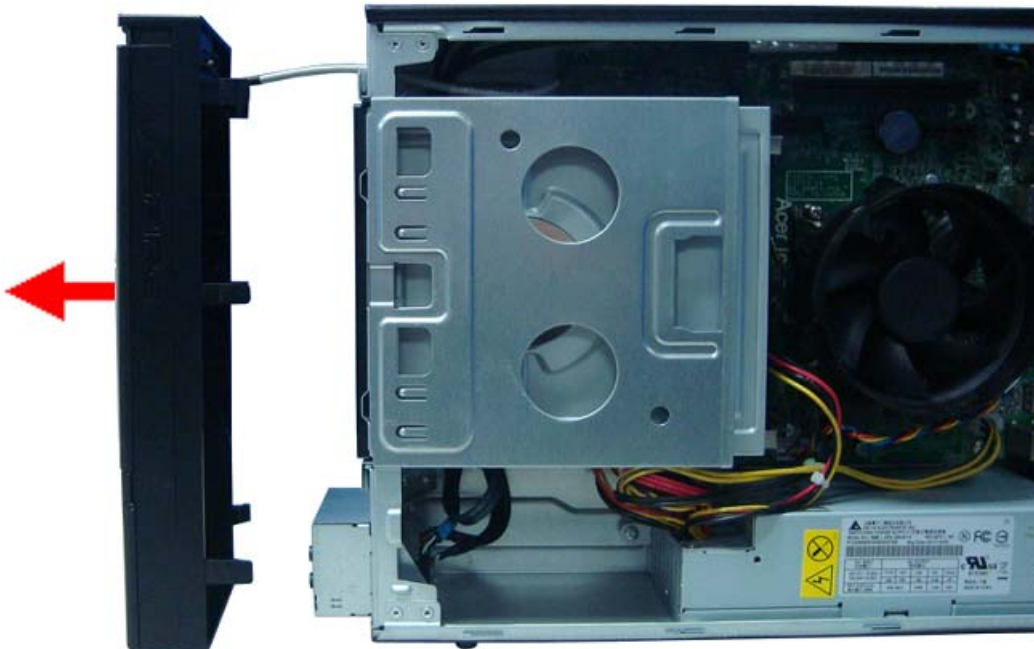

NOTE: The bezel can't be entirely removed until completed below step.due to the other end of power cable connecting with motherboard.

Removing the Heat Sink Fan Assembly

WARNING:The heat sink becomes very hot when the system is on. NEVER touch the heat sink with any metal or with your hands.

1. Use a long-nosed screwdriver to loosen the four screws on the heat sink, in the order as shown below.

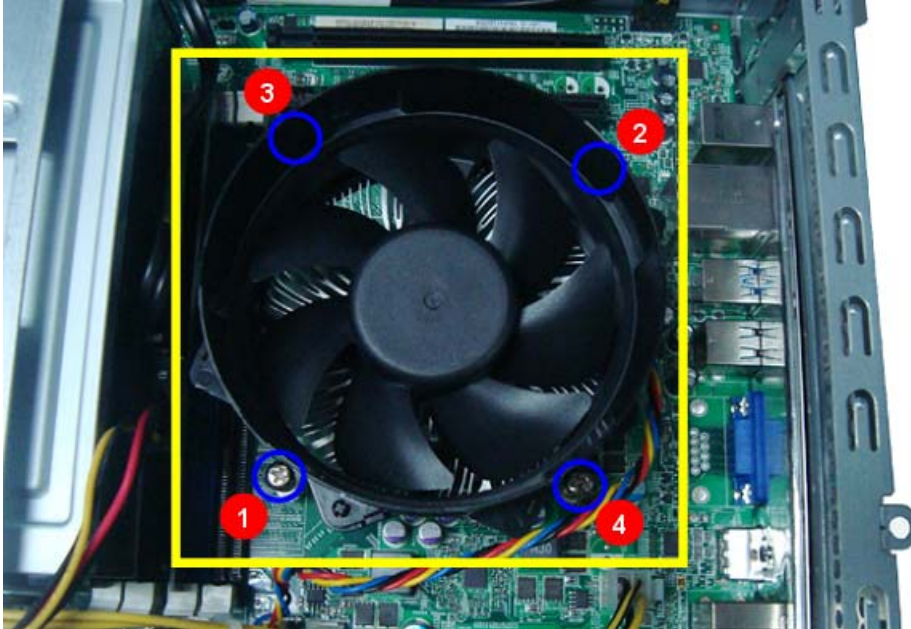

Note:CPU Fan has been highlighted with the yellow rectangle as above image shows.Please detach the CPU

Fan and follow local regulations for disposal.

2. Lift the heat sink fan assembly away from the mainboard.



-
3. Disconnect the fan cable from the mainboard.

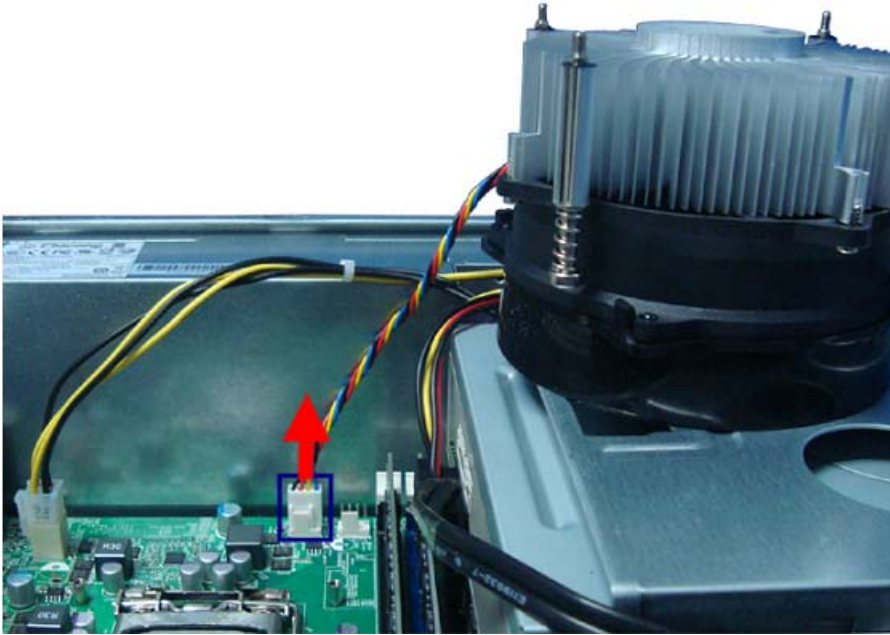

4. Remove the heat sink fan assembly then lay it down in an upright position—with the thermal patch facing upward. Do not let the thermal patch on the heat sink fan assembly touch the work surface.
5. Use an alcohol pad to wipe off the thermal grease from both the heat sink and the processor.

Removing the Processor

IMPORTANT: Before removing a processor from the mainboard, make sure to create a backup file of all important data.

WARNING: The processor becomes very hot when the system is on. Allow it to cool off first before handling.

1. Release the load lever.



2. Lift the load lever and load plate to the fully open, upright position (1) and (2).

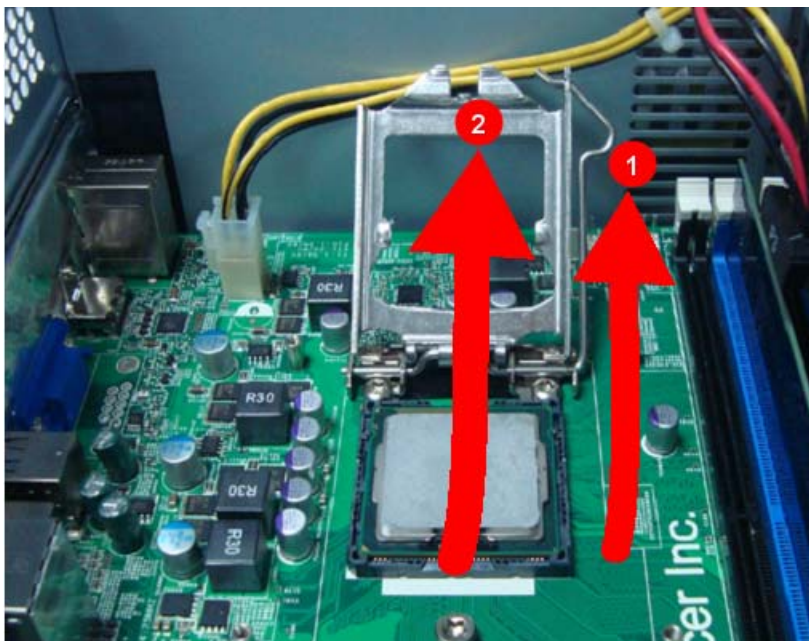

3. Pull out the processor from the socket.

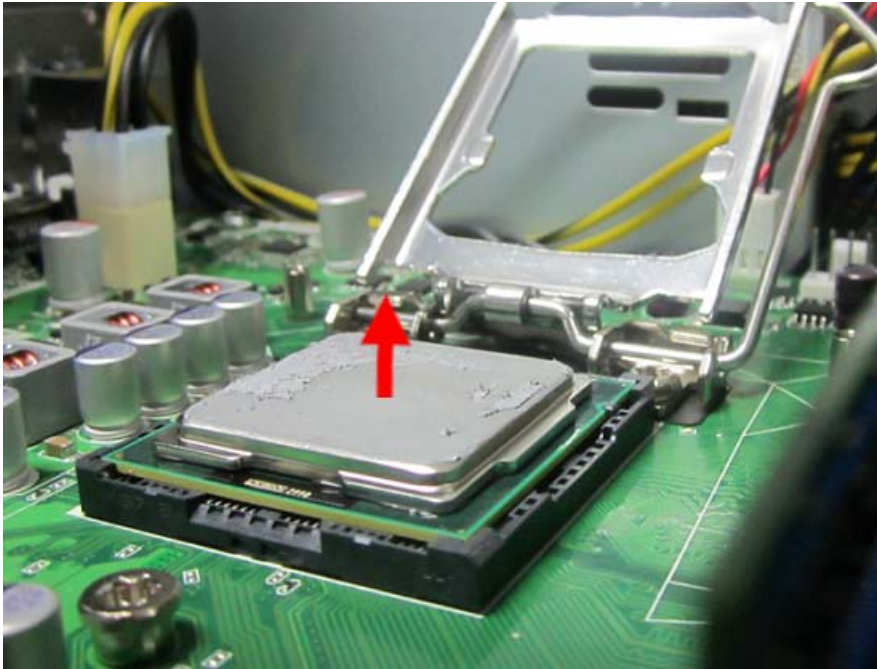

IMPORTANT: If you are going to install a new processor, note the arrow on the corner to make sure the processor is properly oriented over the socket.



Removing the HDD-ODD Bracket

1. Remove the two screws that secure the HDD-ODD bracket to the chassis.



2. Lift the bracket up.

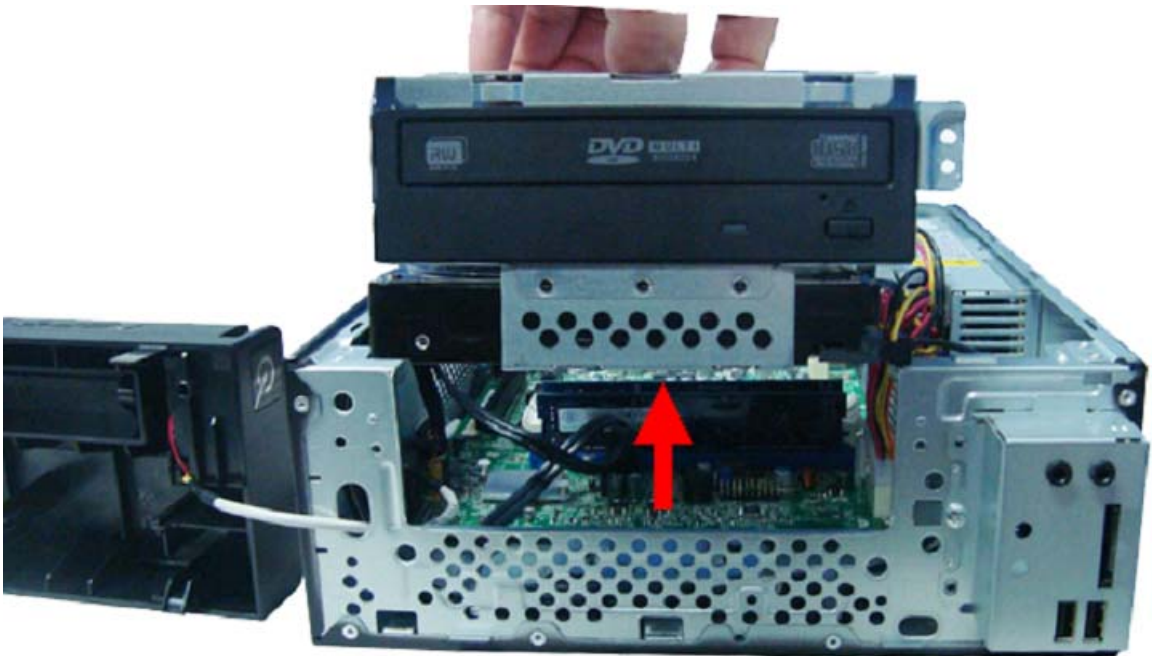

Removing the Optical Drive and the Hard Disk Drive

1. Disconnect the SATA (1) and power (2) cables from the rear of the optical drive.

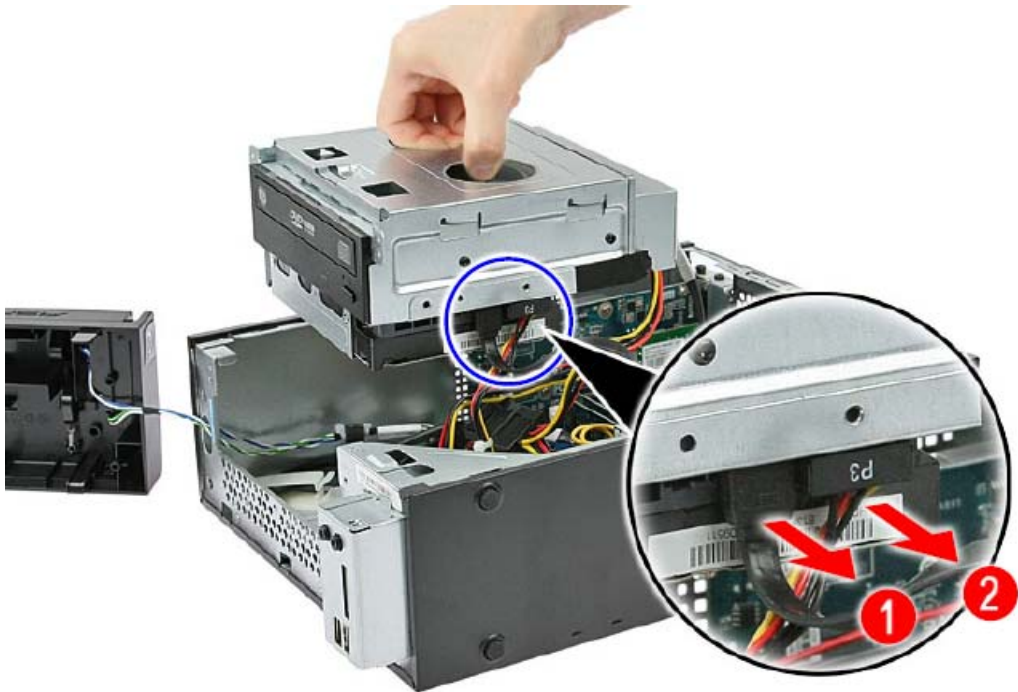

2. Disconnect the other end of the SATA cable from the mainboard.

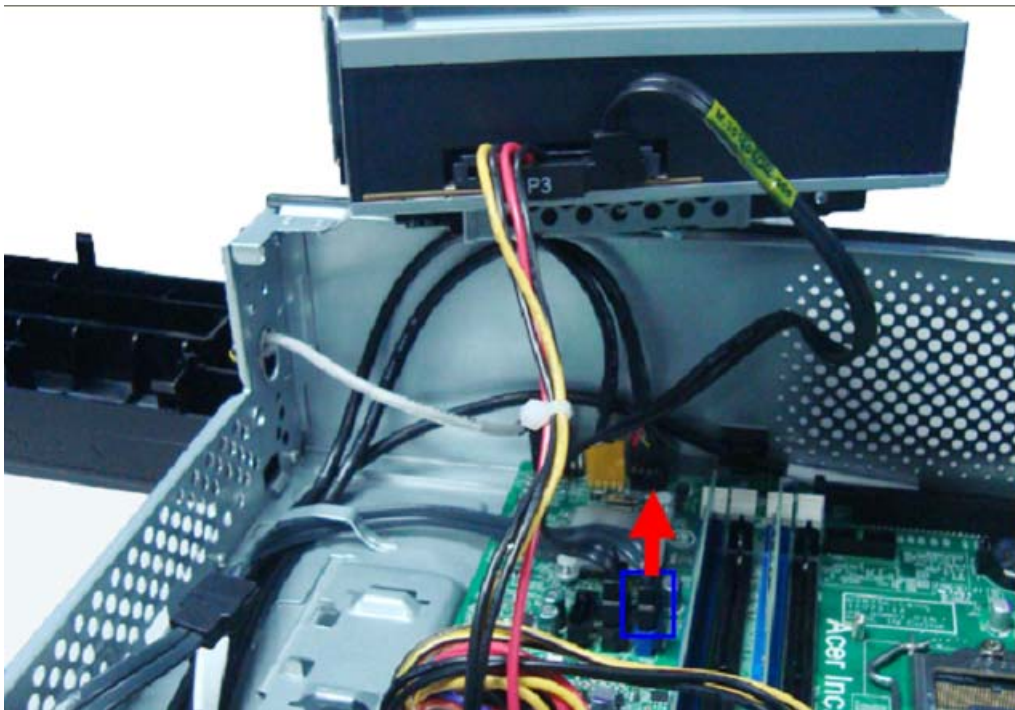

3. Disconnect the SATA (2) and power (1) cables from the rear of the hard disk drive.



4. Disconnect the other end of the SATA cable from the mainboard.

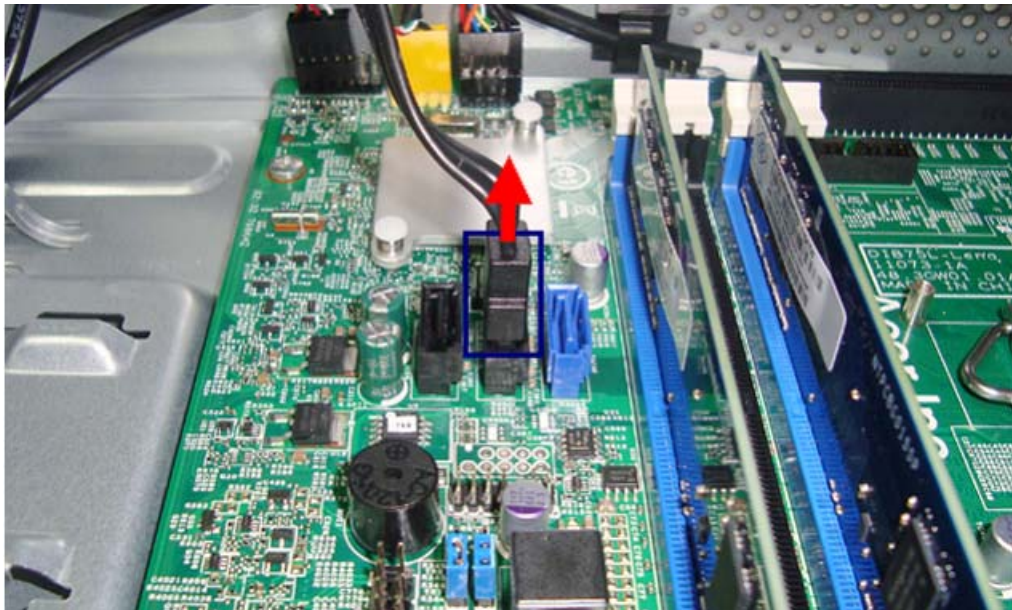

-
5. Remove the screws that secure the optical drive to the HDD-ODD bracket.



6. Pull the optical drive out of the drive bay.



-
7. Remove the four screws that secure the hard disk drive to the HDD bracket.

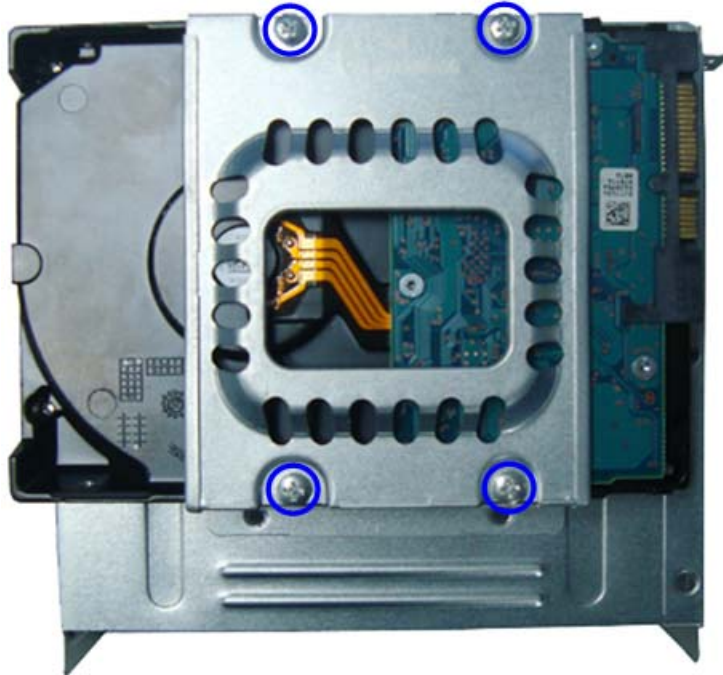

8. Slide the hard disk drive out of the bracket.



Detaching the Front Bezel

1. Disconnect the power button/LED cable from its mainboard connector.

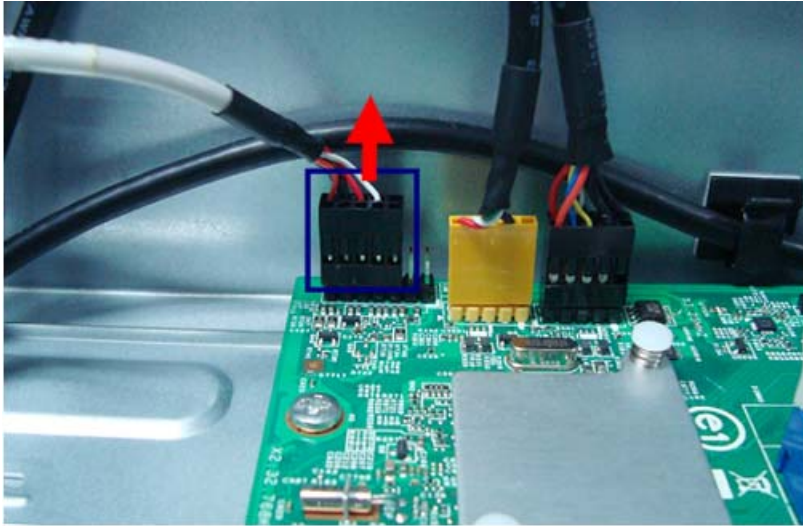

2. Pull out the power button/LED cable from the chassis.



Removing the Memory Modules

IMPORTANT: Before removing any DIMM from the memory board, make sure to create a backup file of all important data.

1. Press the holding clips on both sides of the DIMM slot outward to release the DIMM(1).
2. Gently pull the DIMM upward to pull it away from the M/B(2).

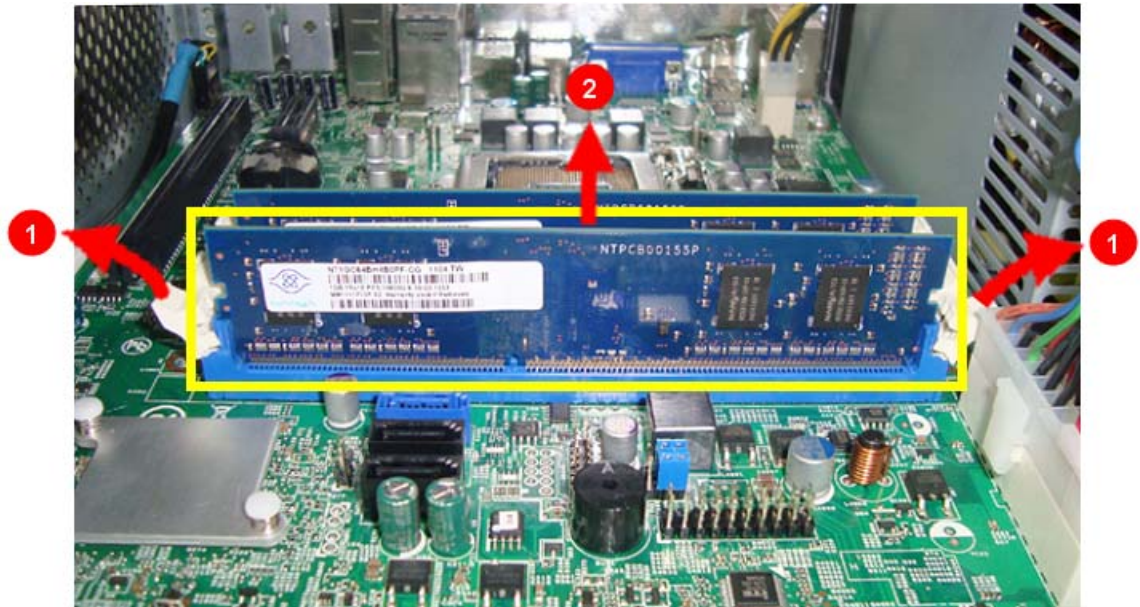

Note: Circuit boards >10 cm² has been highlighted with the yellow rectangle as above image shows. Please detach the Circuit boards and follow local regulations for disposal.

Removing the Power Supply

1. Disconnect the ATX power supply cables from its mainboard connector.
 - a. Squeeze on the retaining latch (1) attached to the cable end of the connector.
 - b. Grasp the cable end of the connector and pull it straight up (2).

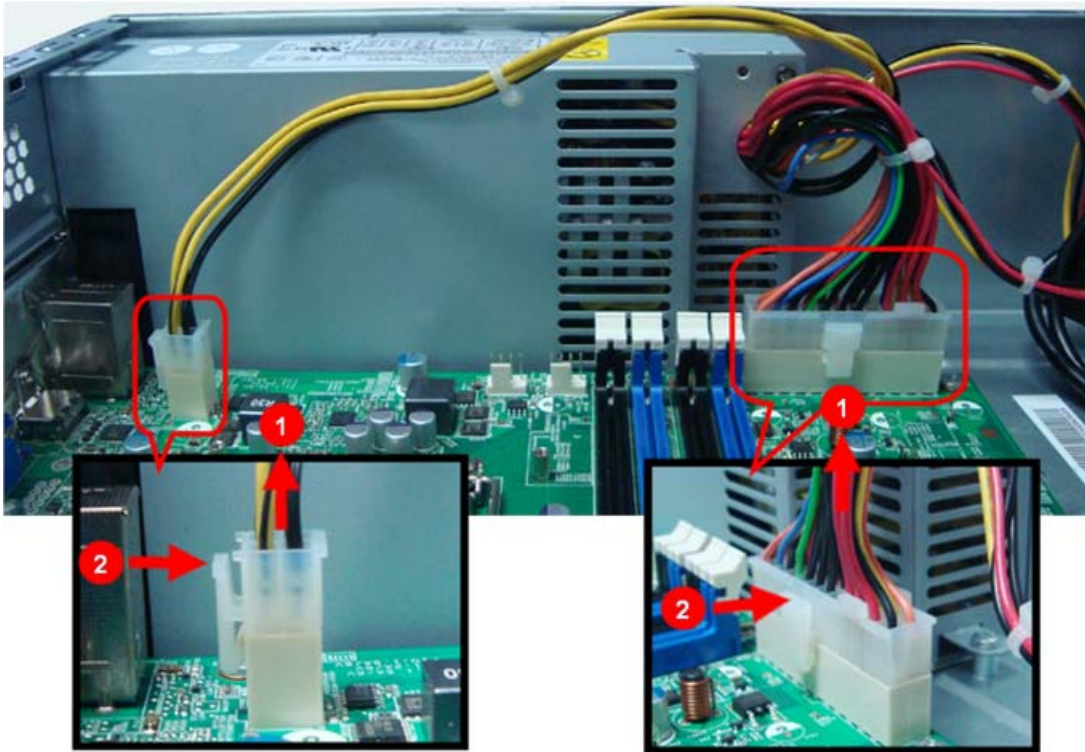

2. Remove the screw that secures the power supply to the chassis.



3. Remove the three screws that secure the power supply to the rear panel.



4. Pull the the power supply module toward the front.



5. Tilt the power supply module slightly to the right and lift it out of the chassis.

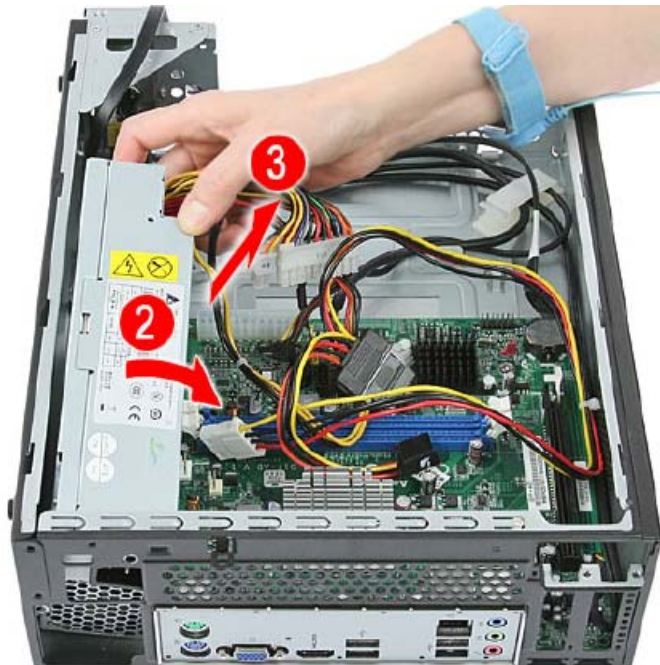

Removing the Front I/O and Optional Card Reader Assembly

1. Release the cable from plastic clip.

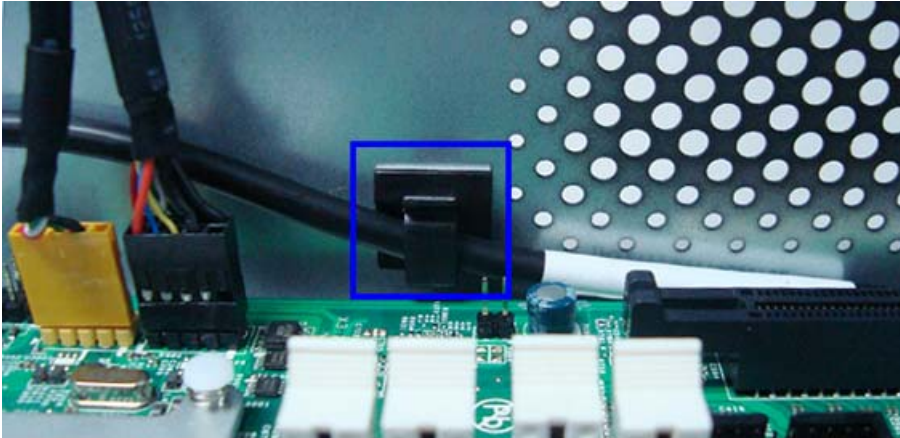

2. Release these cables from the metal clip.

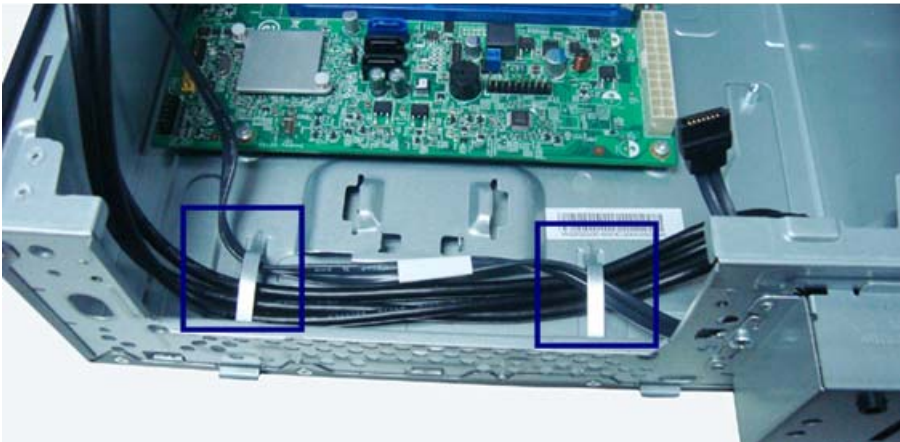

3. Disconnect the front I/O and optional card reader from their mainboard connectors.

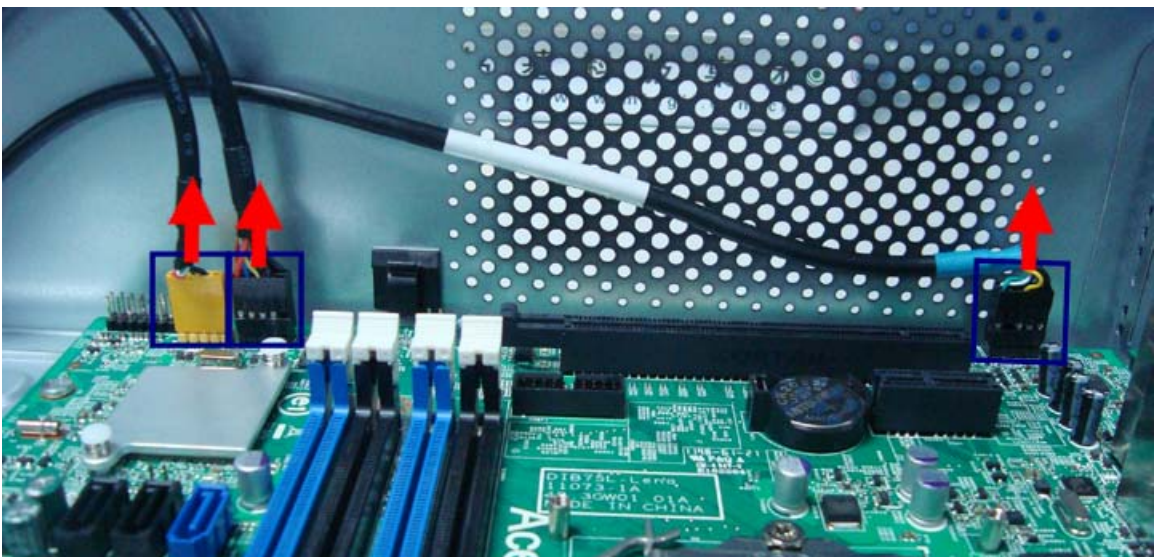

4. Detach the cables from the front I/O and optional card reader. Remove the cables.



5. Remove the screw that secures the bracket to the chassis.



6. Pull the bracket out from the chassis.

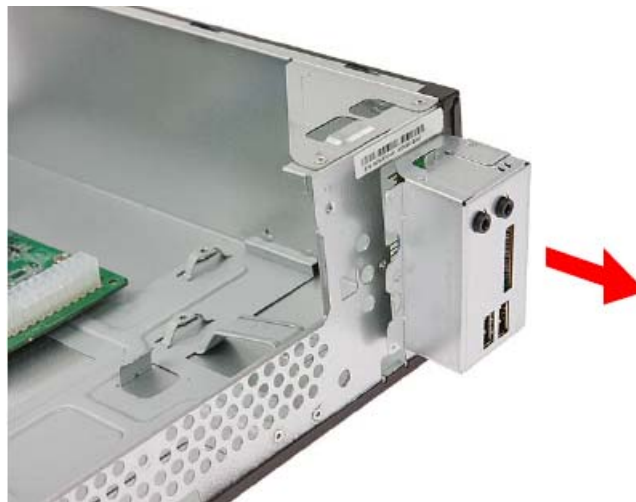

Removing the Mainboard

1. Remove the six screws that secure the mainboard to the chassis.

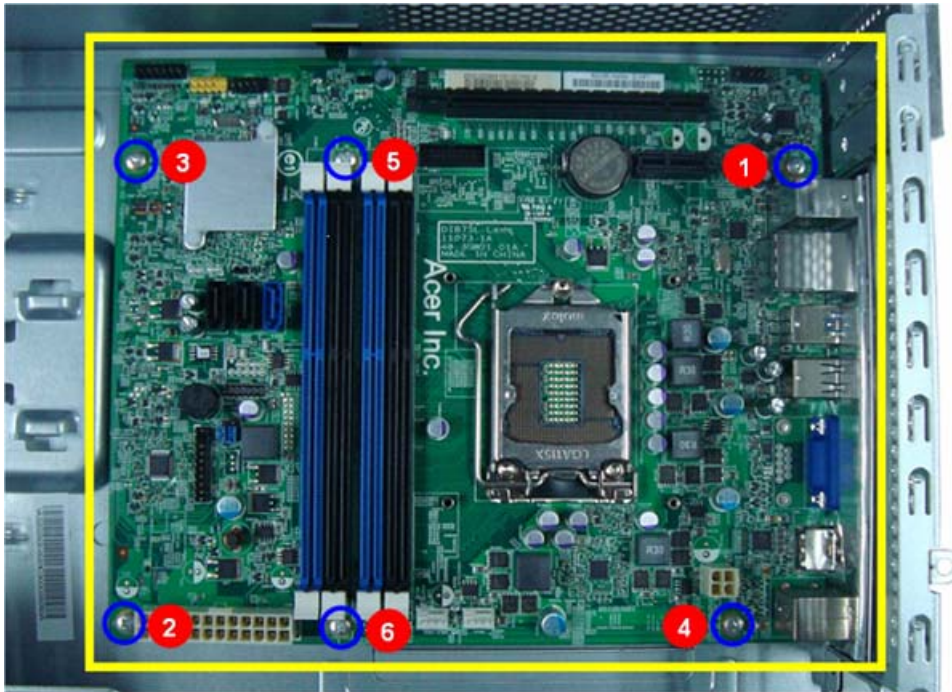

Note: Circuit boards >10 cm² has been highlighted with the yellow rectangle as above image shows.

Please detach the Circuit boards and follow local regulations for disposal.

2. Lift the board from the chassis.

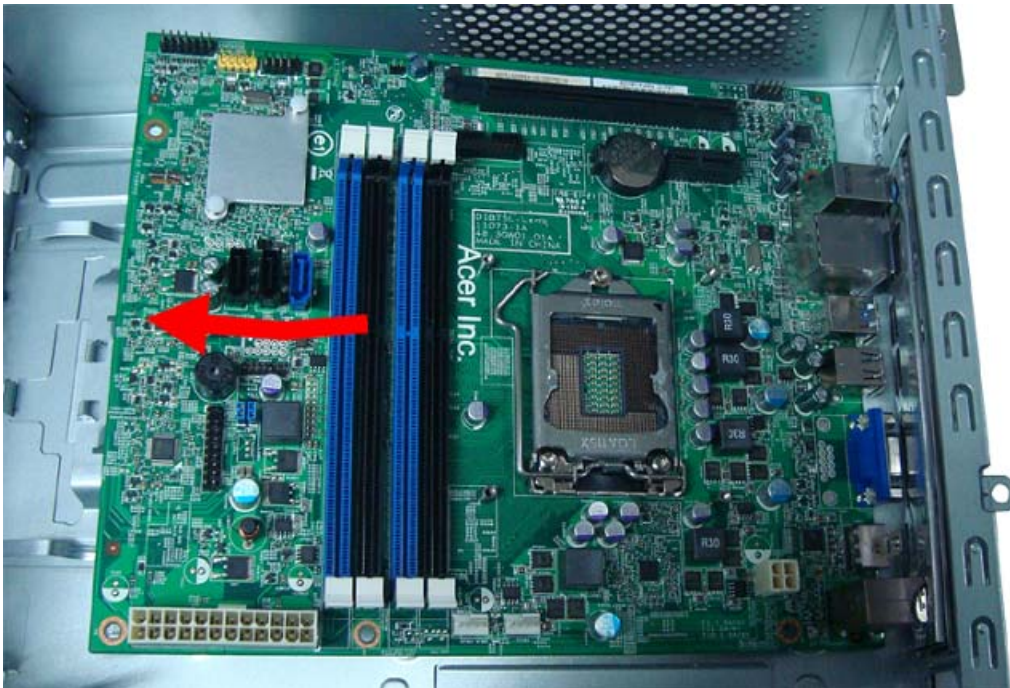

3. Punching in IO Shield then you can remove it.



4. Remove the RTC battery.



Note: RTC battery has been highlighted with the yellow circle as above image shows. Please detach the RTC

battery and follow local regulations for disposal.

Assembly Requirements

To assemble the computer, you need the following tools:

- Wrist grounding strap and conductive mat for preventing electrostatic discharge
- Flat-blade screwdriver
- Philips screwdriver
- Hex screwdriver
- Plastic flat-blade screwdriver
- Plastic tweezers

NOTE: The screws for the different components vary in size. During the assembly process, group the screws with the corresponding components to avoid mismatch when putting back the components.

Assembly Procedure

Before proceeding with the assembly procedure, perform the steps listed below:

1. Turn off the system and all the peripherals connected to it.
2. Unplug the power cord from the power outlets.
3. Unplug the power cord from the system.
4. Unplug all peripheral cables from the system.
5. Place the system unit on a flat, stable surface.

Removing the Side Panel

1. Remove the two screws located on the rear edge of the side panel.



2. Slide the side panel toward the back of the chassis until the tabs on the cover disengage with the slots on the chassis.
3. Lift the side panel away from the server and put it aside for reinstallation later.

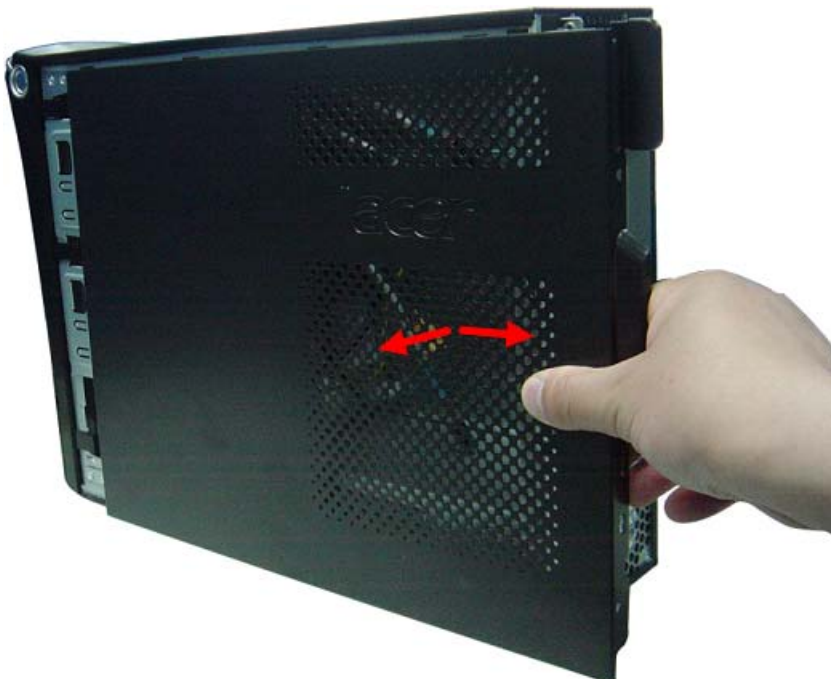

Removing the Front Bezel

1. Release the front bezel from the chassis interior, then pull the bezel away from the chassis.

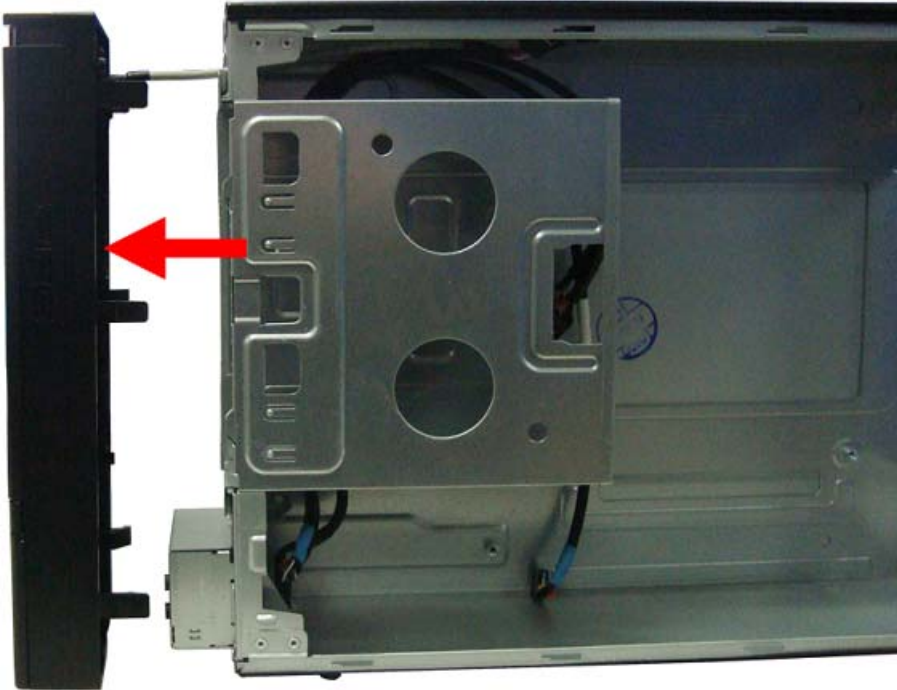

Removing the HDD-ODD Bracket

1. Remove the two screws from chassis.



2. Lift the cage up and turn it over.

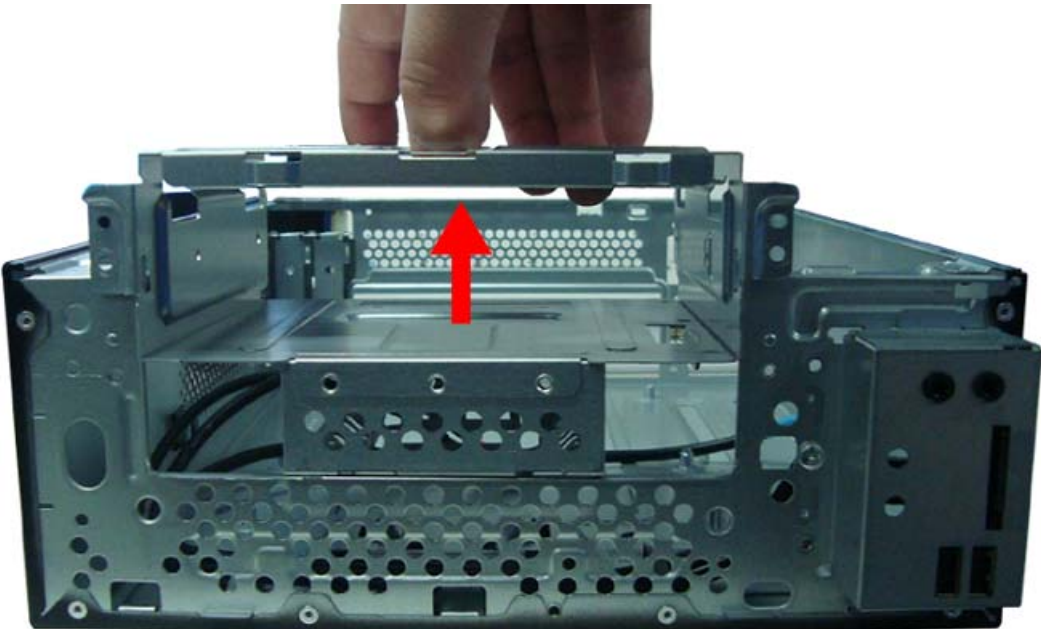

Reinstalling the I/O Shielding

- 1. Install I/O shielding into chassis.



Reinstalling the Main Board

1. Slide the mainboard into the chassis, with the I/O ports of the mainboard extruding from their port holes, then lower the mainboard in place.

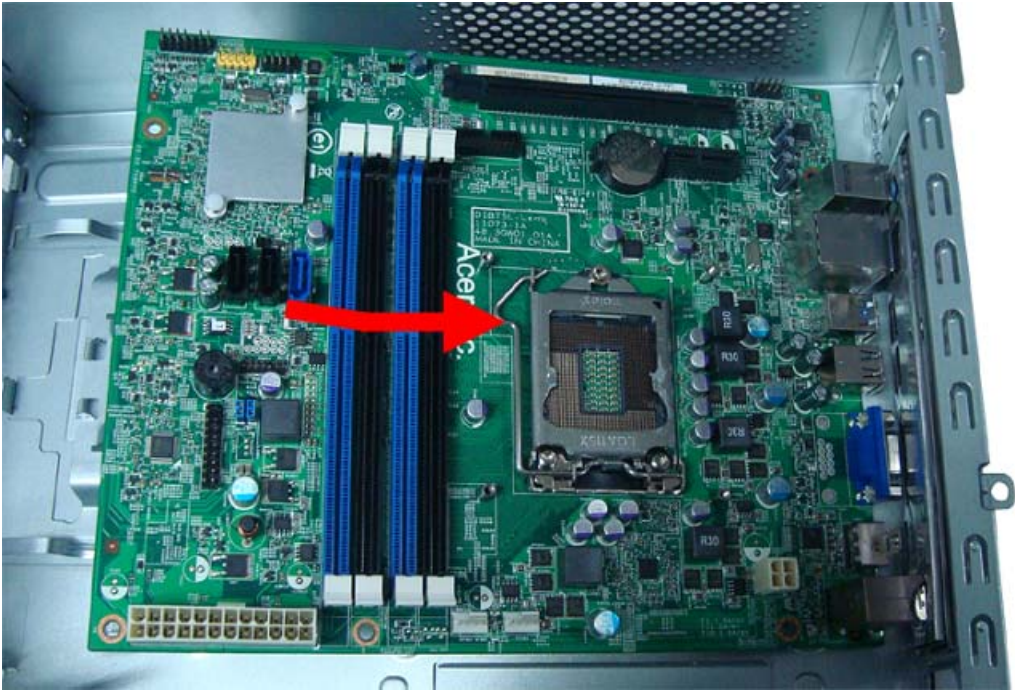

2. Make sure the screw holes on the main board are aligned with those on the chassis. Secure the mainboard with four screws.

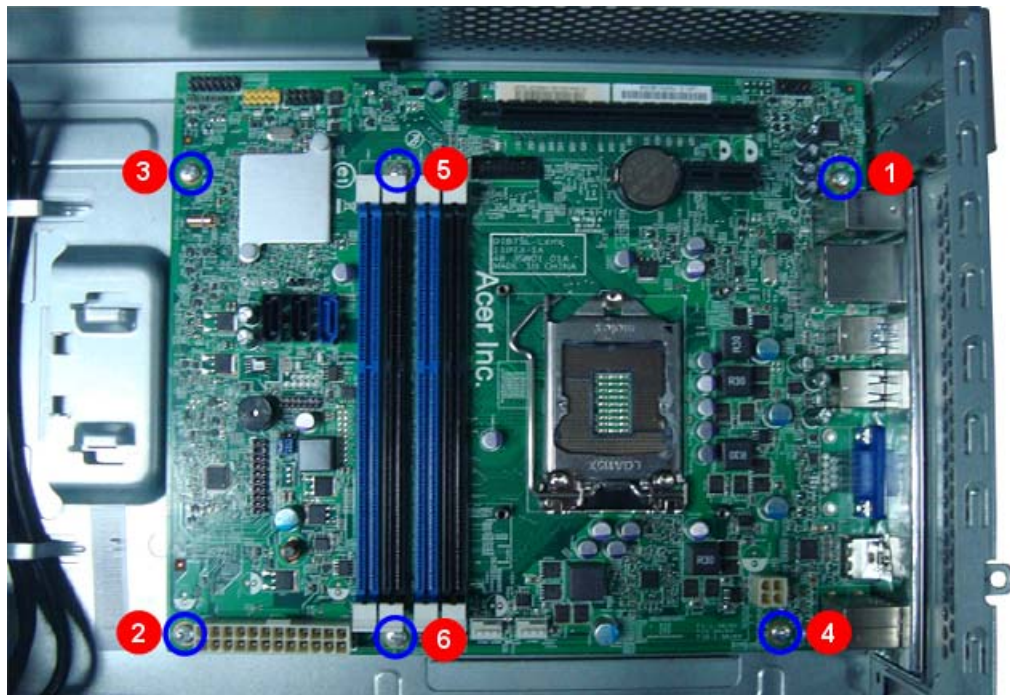

3. Connect the front I/O and optional card reader to the mainboard connectors.

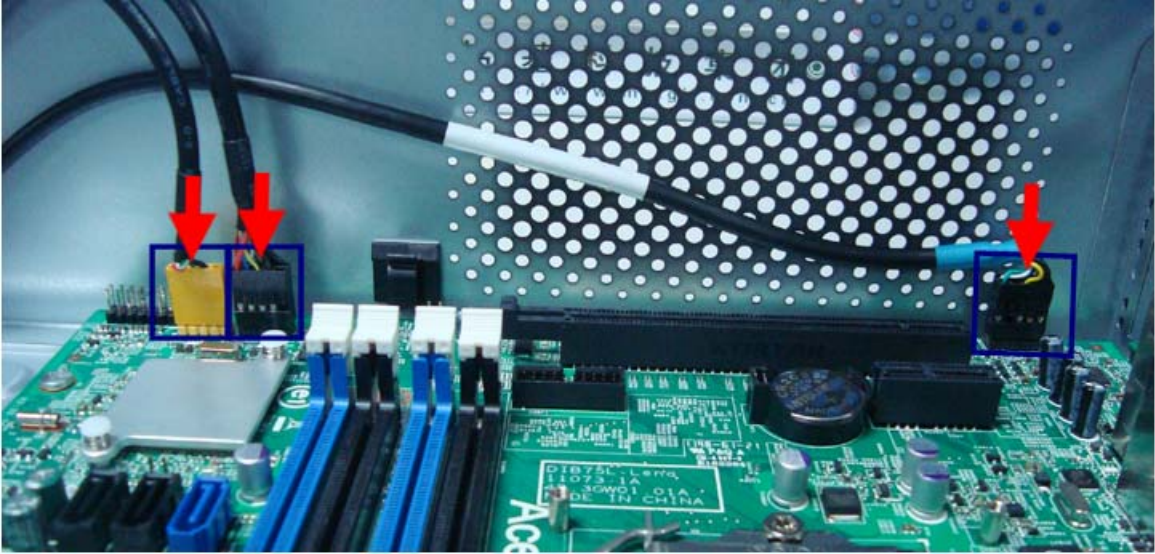

4. Install the retention clip to chassis, then install the front audio cable into the plastic clip.

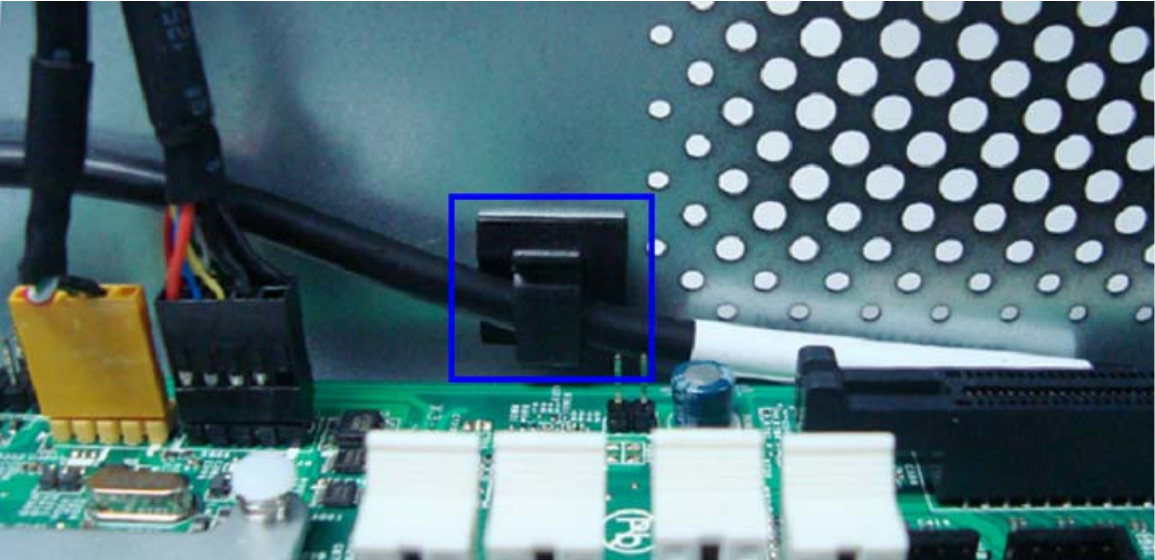

Reinstalling the Power Supply

1. Tilt the power supply module into the chassis (1) and push the power supply module toward the rear (2), with the power connector extruding from the rear panel.

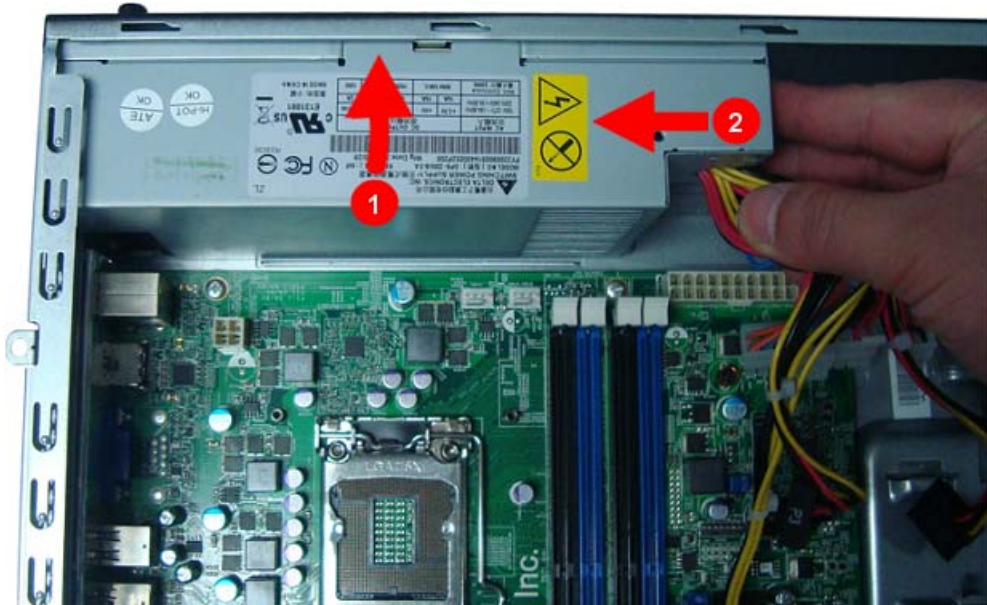

2. Secure the power supply to the rear panel using three screws.



3. Secure the power supply to the chassis using the screw.



4. Connect the ATX 24Pin Power cable and ATX 4Pin Power cable to main board.

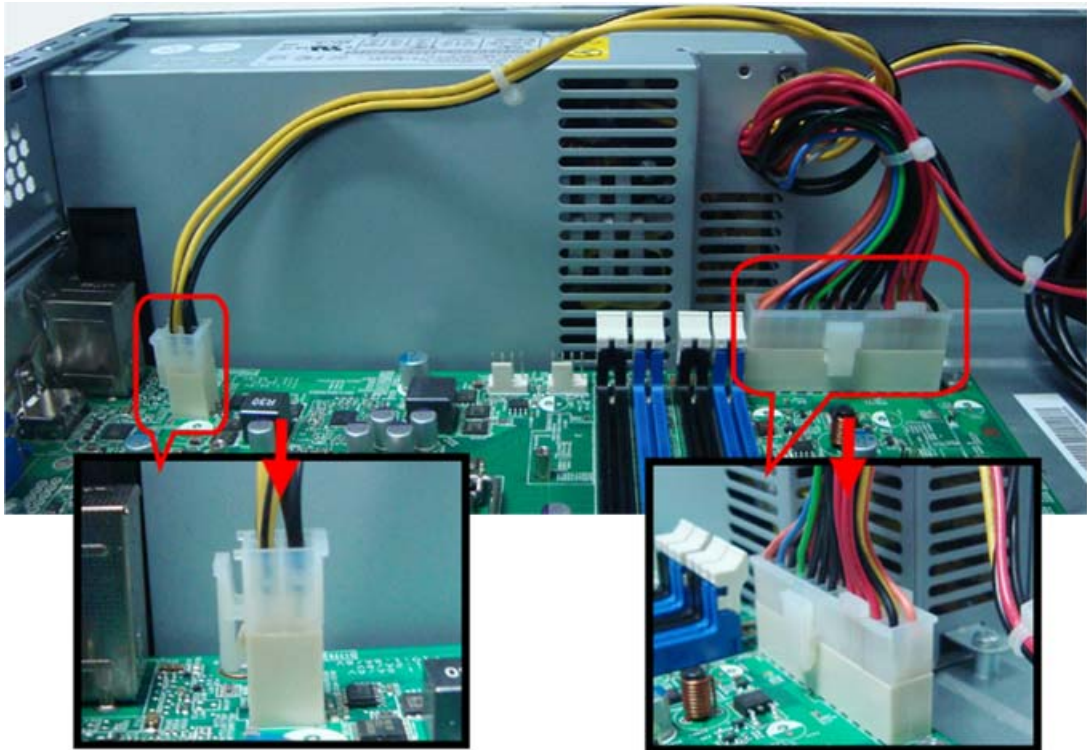

Reinstalling the Memory

1. Open the holding clips on both sides of the DIMM slot outward.



2. Insert the memory module into the DIMM1 slot (1) and then press it down until it clicks into place (2).

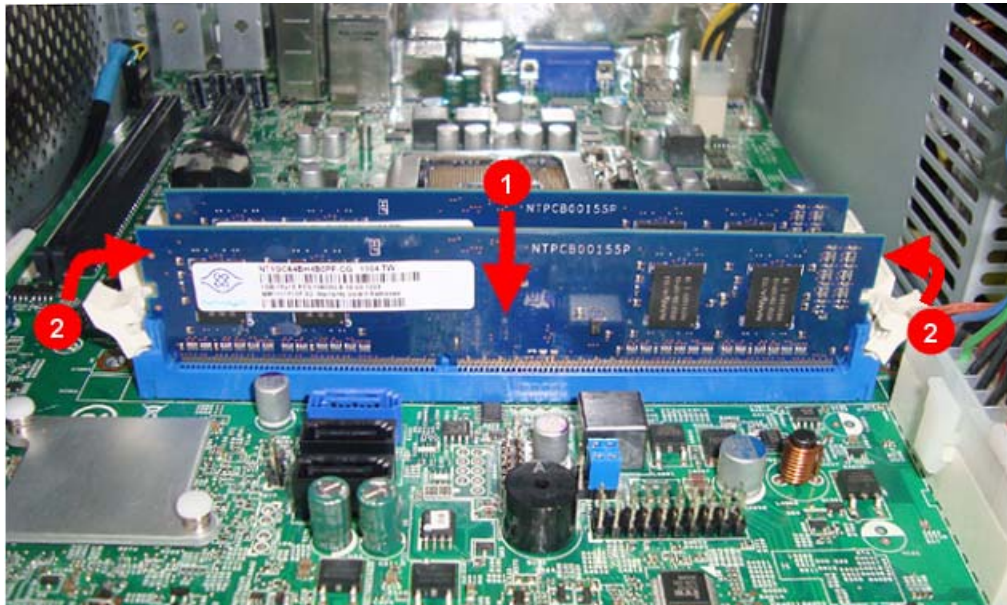

3. If a second memory module is available, install it in the DIMM2 slot by repeating step 1.

Reinstalling the Front Bezel Power Button/LED Cable

1. Insert the power button/LED cable through the front of the chassis.

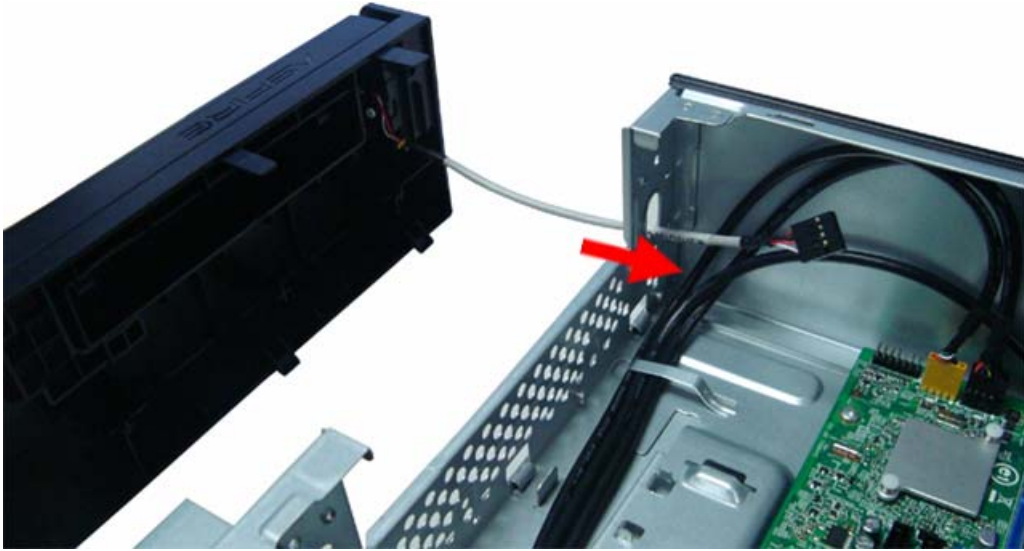

2. Connect the power button/LED cable to its mainboard connector.

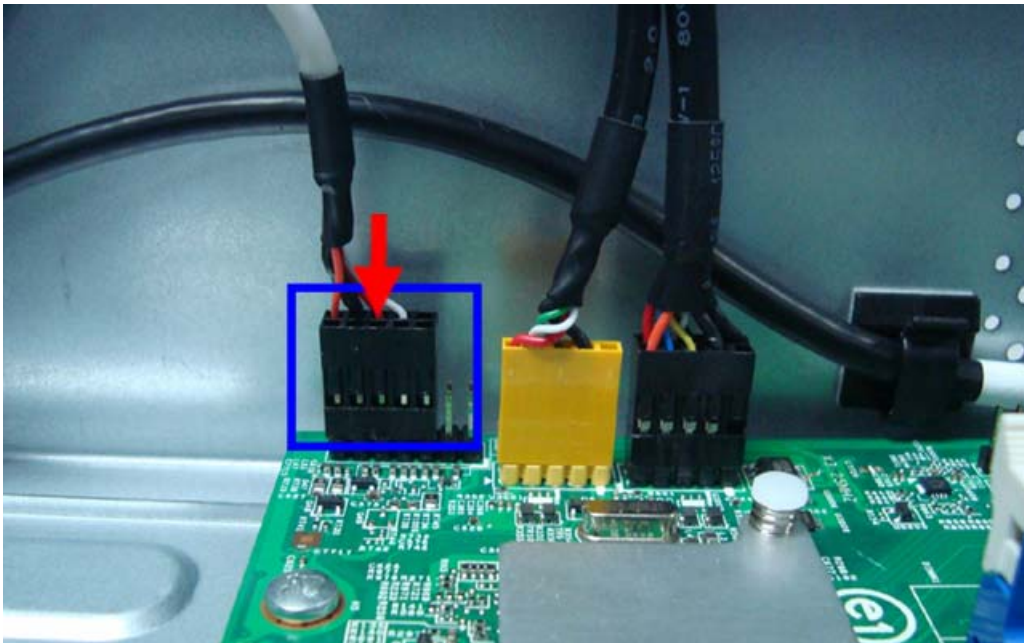

Reinstalling the Optical Drive and the Hard Disk Drive

1. Slide the hard disk drive into the drive bay.

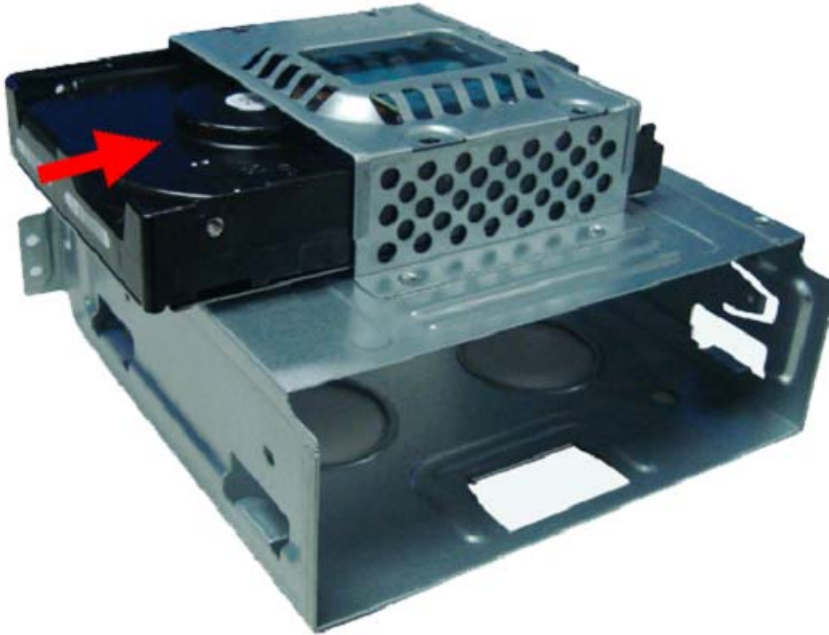

2. Secure the hard disk drive to the HDD-ODD bracket using four screws.



- Slide the optical drive into the drive bay.



- Secure the optical drive to the HDD-ODD bracket using two screws.



- Connect one end of the SATA cable to the SATA connector on the mainboard.



6. Let HDD SATA data cable pass through the two metal clip.

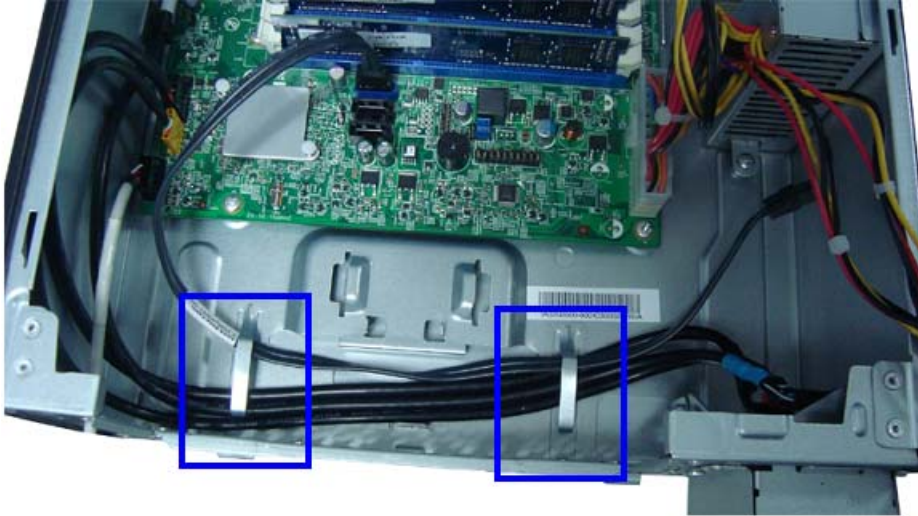

7. Connect the SATA and power cables to their connectors on the rear of the hard disk drive.

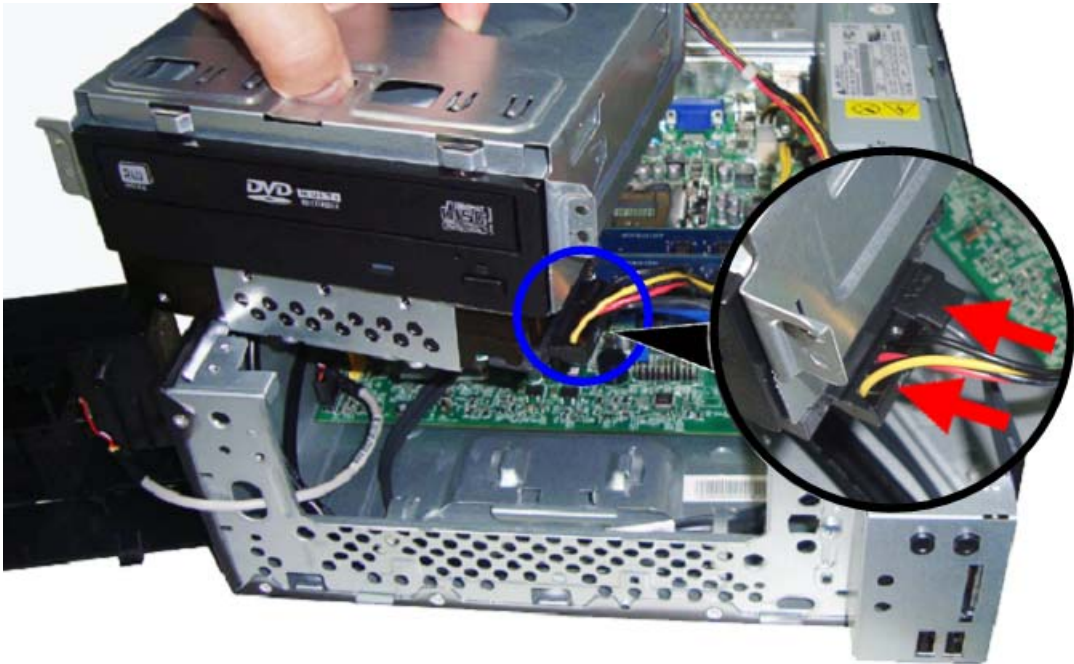

8. Connect one end of the SATA cable to the SATA connector on the mainboard.



9. Connect the SATA and power cables to their connectors on the rear of the optical drive.

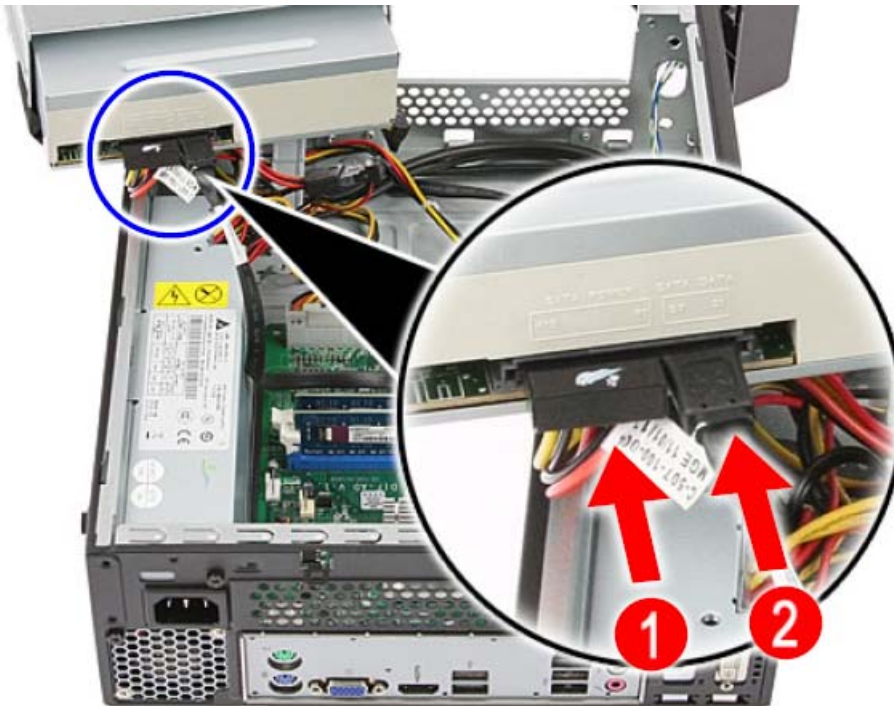

Reinstalling the HDD-ODD Bracket

1. Install the HDD-ODD bracket into the chassis.

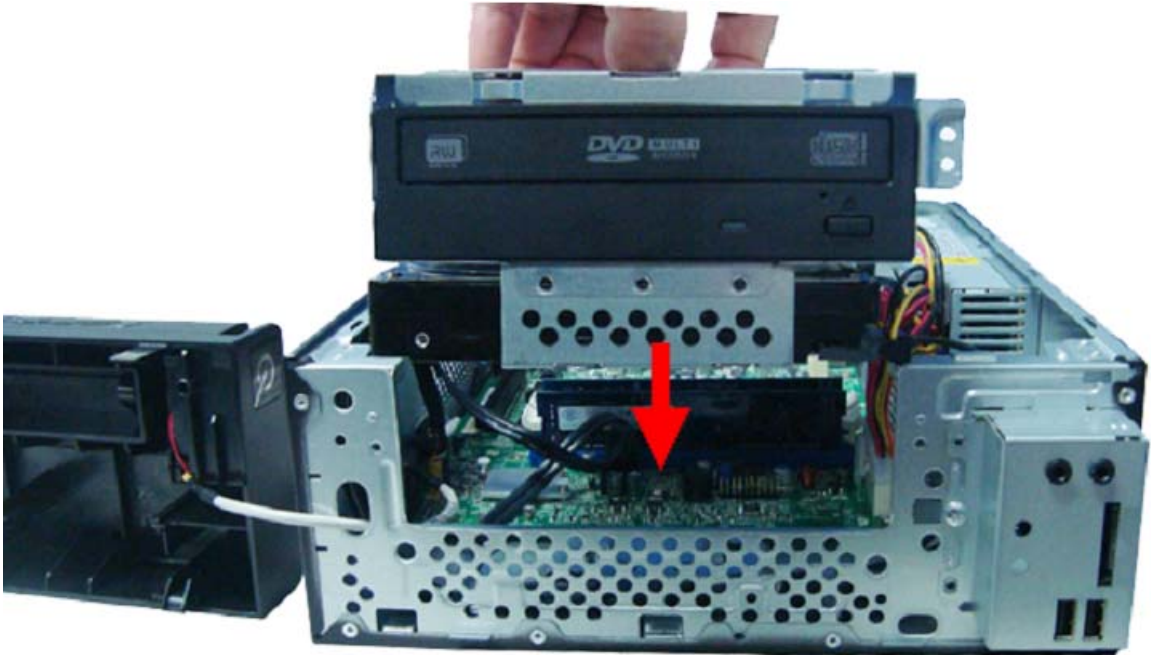

2. Secure the HDD-ODD bracket to the chassis using two screws.



Reinstalling the Processor

1. Release the load lever.

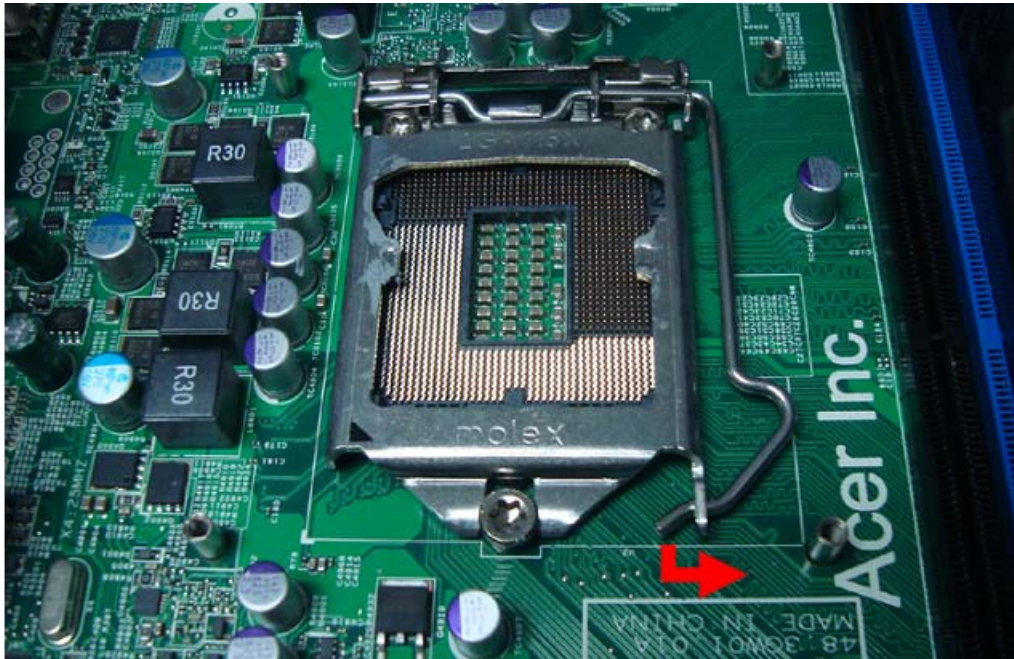

2. Lift the load lever and load plate to the fully open, upright position (1) and (2).

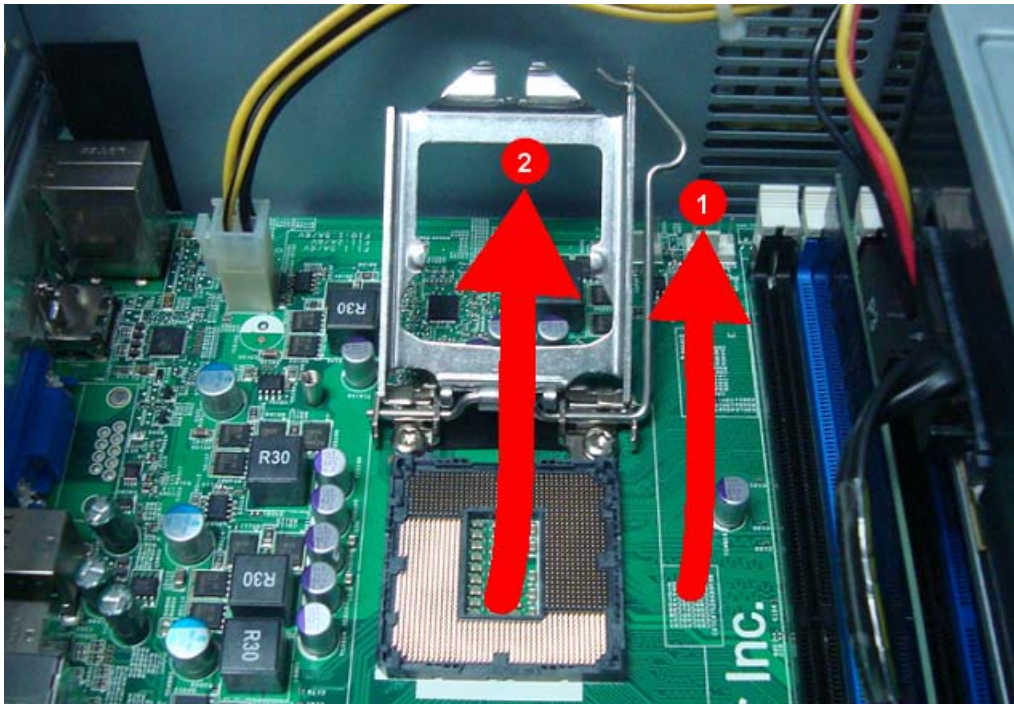

3. Gently put the processor to the socket., then close the retention plate and the load lever to its latch.



IMPORTANT: If you are going to install a new processor, note the arrow on the corner to make sure the processor is properly oriented over the socket.



Reinstalling the Heat Sink Fan Assembly

1. Connect the cooler cable to the main board connector.

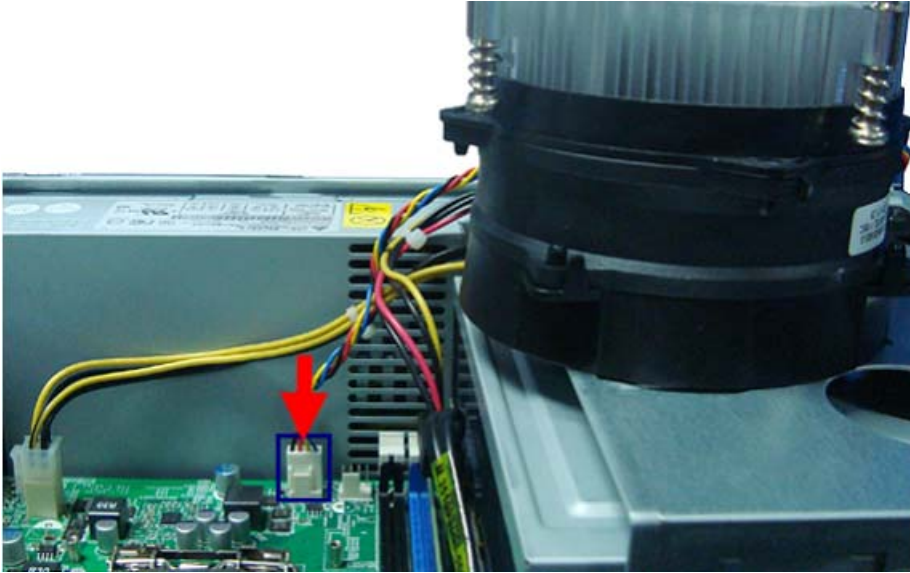

2. Position the heat sink fan assembly on top of the processor, making sure the screws are aligned with the screw holes on the main board.



-
3. Secure the heat sink fan assembly to the screw holes on the main board using four screws.

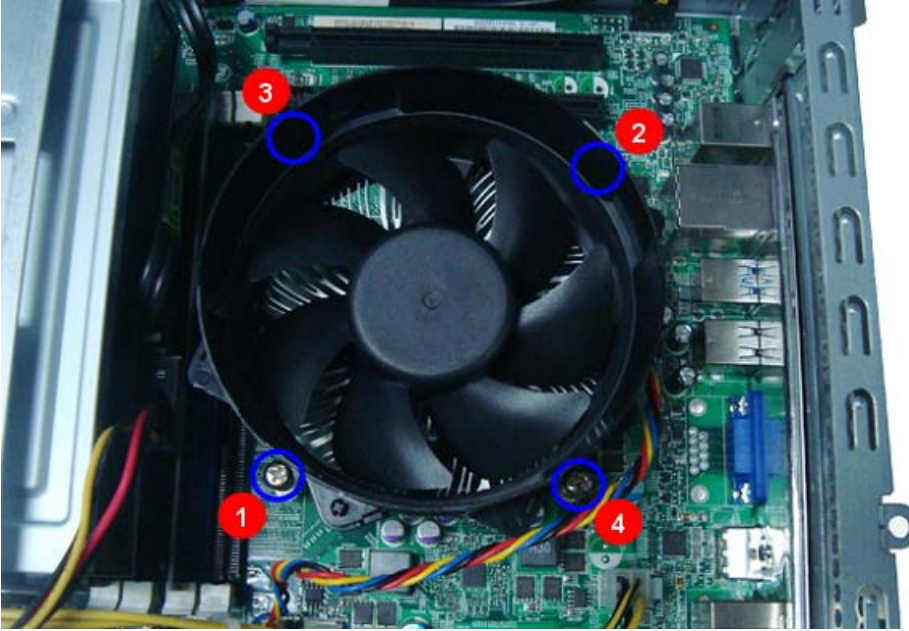

Reinstalling the Front Bezel

1. Insert the tabs on the front bezel into the notches (1) on the left side of the chassis and attach the front bezel (2) in the direction indicated.

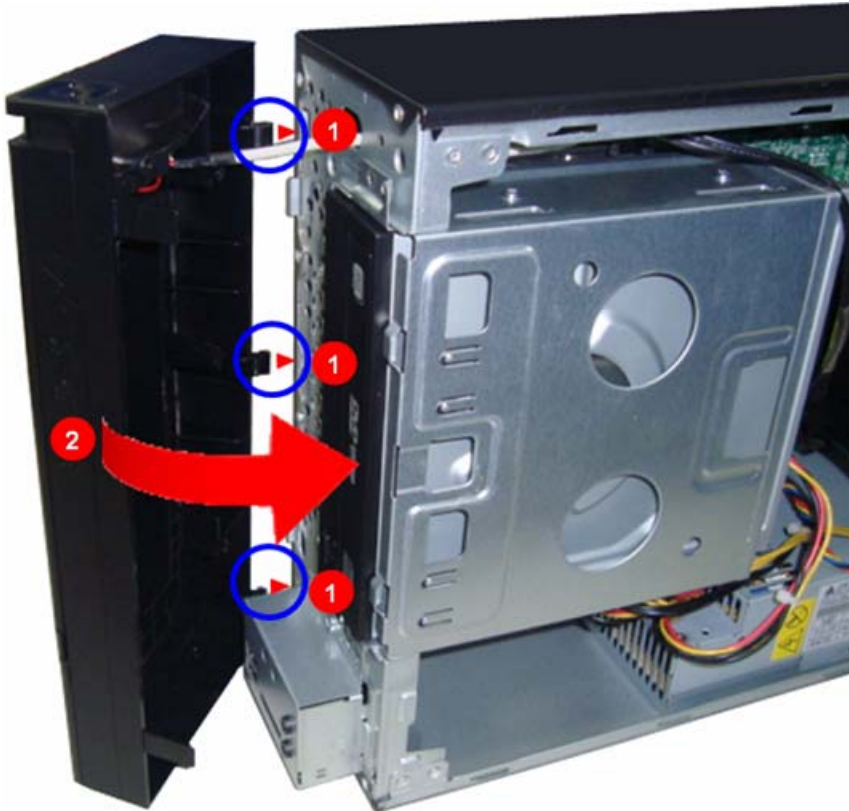

2. Make sure the front bezel retention tabs are securely fastened to the chassis interior.



Reinstalling the Side Panel

1. Align the tabs on the lower edge of the side panel with the notches on the bottom side of the chassis.



2. Align the tabs on the upper edge of the side panel with the notches on the top side of the chassis.

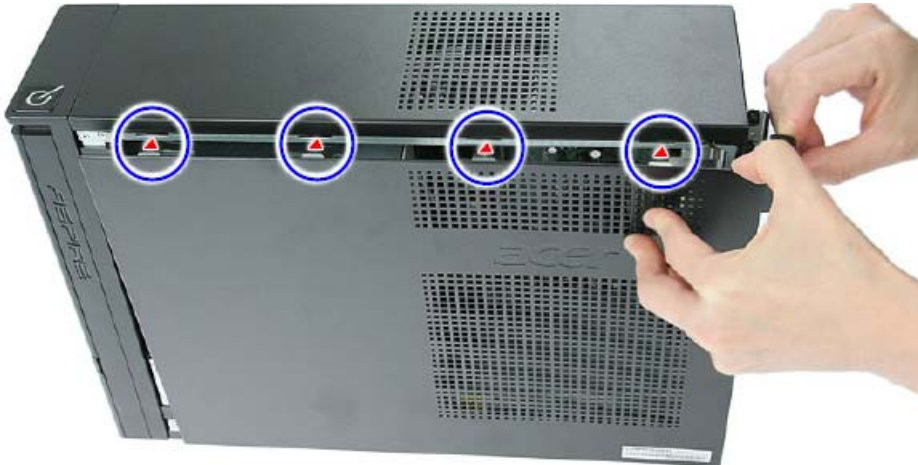

-
3. Push the side panel toward the front of the chassis until it is firmly closed.

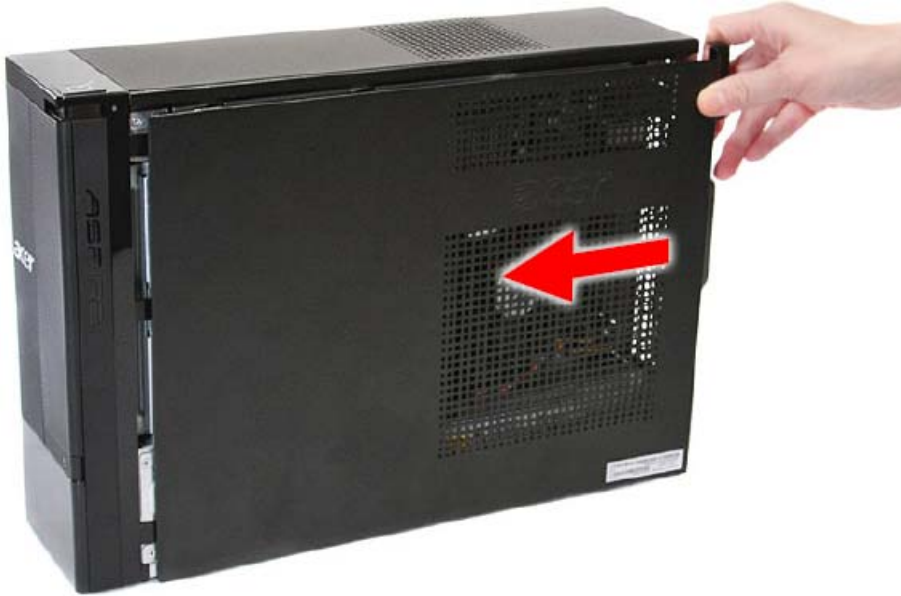

4. Secure the side panel to the rear edge of the chassis using two screws.



System Troubleshooting

This chapter provides instructions on how to troubleshoot system hardware problems.

Hardware Diagnostic Procedure

IMPORTANT: The diagnostic tests described in this chapter are only intended to test Acer products. Non-Acer products, prototype cards, or modified options can give false errors and invalid system responses.

1. Obtain the failing symptoms in as much detail as possible.
2. Verify the symptoms by attempting to recreate the failure by running the diagnostic tests or repeating the same operation.
3. Refer to “Power System check” on page 71 and “Beep Codes” on page 72 to determine which corrective action to perform.

System Check Procedures

Power System Check

If the system will power on, skip this section. Refer to System External Inspection.

If the system will not power on, do the following:

- Check if the power cable is properly connected to the system and AC source.
- Check if the voltage selector switch is set to the correct voltage setting.

System External Inspection

1. Inspect the LED indicators on the front panel, which can indicate the malfunction.
2. Make sure that air flow is not blocked.
3. Make sure nothing in the system is making contact that could short out power.
4. If the problem is not evident, continue with System Internal Inspection.

System Internal Inspection

1. Turn off the system and all the peripherals connected to it.
2. Unplug the power cord from the power outlets.
3. Unplug the power cord from the system.
4. Unplug all peripheral cables from the system.
5. Place the system unit on a flat, stable surface.
6. Remove the system covers. For instructions on removing system covers, refer to “System Disassembly” on page 25.
7. Verify that components are properly seated.
8. Verify that all cable connectors inside the system are firmly and correctly attached to their appropriate connectors.
9. Verify that all components are Acer-qualified and supported.
10. Replace the system covers.
11. Power on the system.
12. If the problem with the system is not evident, you can try viewing the POST messages and BIOS event logs during the system startup.

Beep Codes

Beep codes are used by the BIOS to indicate a serious or fatal error to the end user. Beep codes are used when an error occurs before the system video has been initialized. Beep codes will be generated by the system board speaker, commonly referred to as the PC speaker.

AMIBIOS displays the checkpoints in the bottom right corner of the screen during POST. This display method is limited, since it only displays checkpoints that occur after the video card has been activated.

Not all computers using AMIBIOS enable this feature. In most cases, a checkpoint card is the best tool for viewing AMIBIOS checkpoints.

Beep Symptom	Cause and Description
One short beep	System is ready. System is OK.
Continuous one long beep	Memory not installed or memory error.
One long beep and two short beeps then repeat.	VGA not installed or VGA error. Graphics card error/not installed, graphics card memory error or graphics card BIOS checksum error.
One long beep then two short beep	BIOS damaged. BIOS is damaged, BIOS POST jumps to Boot Block to execute the default procedures.
Two short beeps	CMOS damaged. CMOS checksum error or CMOS battery loss occurs.

Checkpoints

A checkpoint is either a byte or word value output to I/O port 80h. The BIOS outputs checkpoints throughout bootblock and Power-On Self Test (POST) to indicate the task the system is currently executing. Checkpoints are very useful in aiding software developers or technicians in debugging problems that occur during the pre-boot process.

Viewing BIOS checkpoints

Viewing all checkpoints generated by the BIOS requires a checkpoint card, also referred to as a POST card or POST diagnostic card. These are ISA or PCI add-in cards that show the value of I/O port 80h on a LED display. Checkpoints may appear on the bottom right corner of the screen during POST. This display method is limited, since it only displays checkpoints that occur after the video card has been activated.

Bootblock Initialization Code Checkpoints

The Bootblock initialization code sets up the chipset, memory, and other components before system memory is available. The following table describes the type of checkpoints that may occur during the bootblock initialization portion of the BIOS.

NOTE: Please note that checkpoints may differ between different platforms based on system configuration. Checkpoints may change due to vendor requirements, system chipset or option ROMs from add-in PCI devices.

Checkpoint	Description
Before D0	If boot block debugger is enabled, CPU cache-as-RAM functionality is enabled at this point. Stack will be enabled from this point.
D0	Early Boot Strap Processor (BSP) initialization like microcode update, frequency and other CPU critical initialization. Early chipset initialization is done.
D1	Early super I/O initialization is done including RTC and keyboard controller. Serial port is enabled at this point if needed for debugging. NMI is disabled. Perform keyboard controller BAT test. Save power-on CPUID value in scratch CMOS. Go to flat mode with 4GB limit and GA20 enabled.
D2	Verify the boot block checksum. System will hang here if checksum is bad.
D3	Disable CACHE before memory detection. Execute full memory sizing module. If memory sizing module not executed, start memory refresh and do memory sizing in Boot block code. Do additional chipset initialization. Re-enable CACHE. Verify that flat mode is enabled.
D4	Test base 512KB memory. Adjust policies and cache first 8MB. Set stack.
D5	Bootblock code is copied from ROM to lower system memory and control is given to it. BIOS now executes out of RAM. Copies compressed boot block code to memory in right segments. Copies BIOS from ROM to RAM for faster access. Performs main BIOS checksum and updates recovery status accordingly.
D6	Both key sequence and OEM specific method is checked to determine if BIOS recovery is forced. Main BIOS checksum is tested. If BIOS recovery is necessary, control flows to checkpoint E0. See Bootblock Recovery Code Checkpoints section for more information.
D7	Restore CPUID value back into register. The Bootblock-Runtime interface module is moved to system memory and control is given to it. Determine whether to execute serial flash.
D8	The Runtime module is uncompressed into memory. CPUID information is stored in memory.
D9	Store the Uncompressed pointer for future use in PMM. Copying Main BIOS into memory. Leaves all RAM below 1MB Read-Write including E000 and F000 shadow areas but closing SMRAM.

Checkpoint	Description
DA	Restore CPUID value back into register. Give control to BIOS POST (ExecutePOSTKernel). See POST Code Checkpoints section of document for more information.
DC	System is waking from ACPI S3 state.
E1-E8 EC-EE	OEM memory detection/configuration error. This range is reserved for chipset vendors & system manufacturers. The error associated with this value may be different from one platform to the next.

Bootblock Recovery Code Checkpoints

The Bootblock recovery code gets control when the BIOS determines that a BIOS recovery needs to occur because the user has forced the update or the BIOS checksum is corrupt. The following table describes the type of checkpoints that may occur during the Bootblock recovery portion of the BIOS.

NOTE: Checkpoints may differ between different platforms based on system configuration. Checkpoints may change due to vendor requirements, system chipset or option ROMs from add-in PCI devices.

Checkpoint	Description
E0	Initialize the floppy controller in the super I/O. Some interrupt vectors are initialized. DMA controller is initialized. 8259 interrupt controller is initialized. L1 cache is enabled.
E9	Set up floppy controller and data. Attempt to read from floppy.
EA	Enable ATAPI hardware. Attempt to read from ARMD and ATAPI CDROM.
EB	Disable ATAPI hardware. Jump back to checkpoint E9.
EF	Read error occurred on media. Jump back to checkpoint EB.
F0	Search for pre-defined recovery file name in root directory.
F1	Recovery file not found.
F2	Start reading FAT table and analyze FAT to find the clusters occupied by the recovery file.
F3	Start reading the recovery file cluster by cluster.
F5	Disable L1 cache.
FA	Check the validity of the recovery file configuration to the current configuration of the flash part.
FB	Make flash write enabled through chipset and OEM specific method. Detect proper flash part. Verify that the found flash part size equals the recovery file size.
F4	The recovery file size does not equal the found flash part size.
FC	Erase the flash part
FD	Program the flash part.
FF	The flash has been updated successfully. Make flash write disabled. Disable ATAPI hardware. Restore CPUID value back into register. Give control to F000 ROM at F000:FFF0h.

BIOS Recovery

AMIBIOS supports a "recovery flash" mode, which can be used to flash update a BIOS from the boot block. This is used to update a BIOS image without the need to boot to an operating system. The following is the process that user should follow to flash BIOS ROM.

1. Put the AMIBoot.ROM to a bootable USB flash drive(Disk on Key, DOK).
2. Install the DOK to the system.
3. Press power button to boot the system and then press Ctrl + Home.
4. The BIOS recovery function will be executed.
5. After BIOS is updated completely, the system will auto reboot.
6. Please enter the setup menu to load default after system reboot.

Jumper and Connector Information

M/B Placement

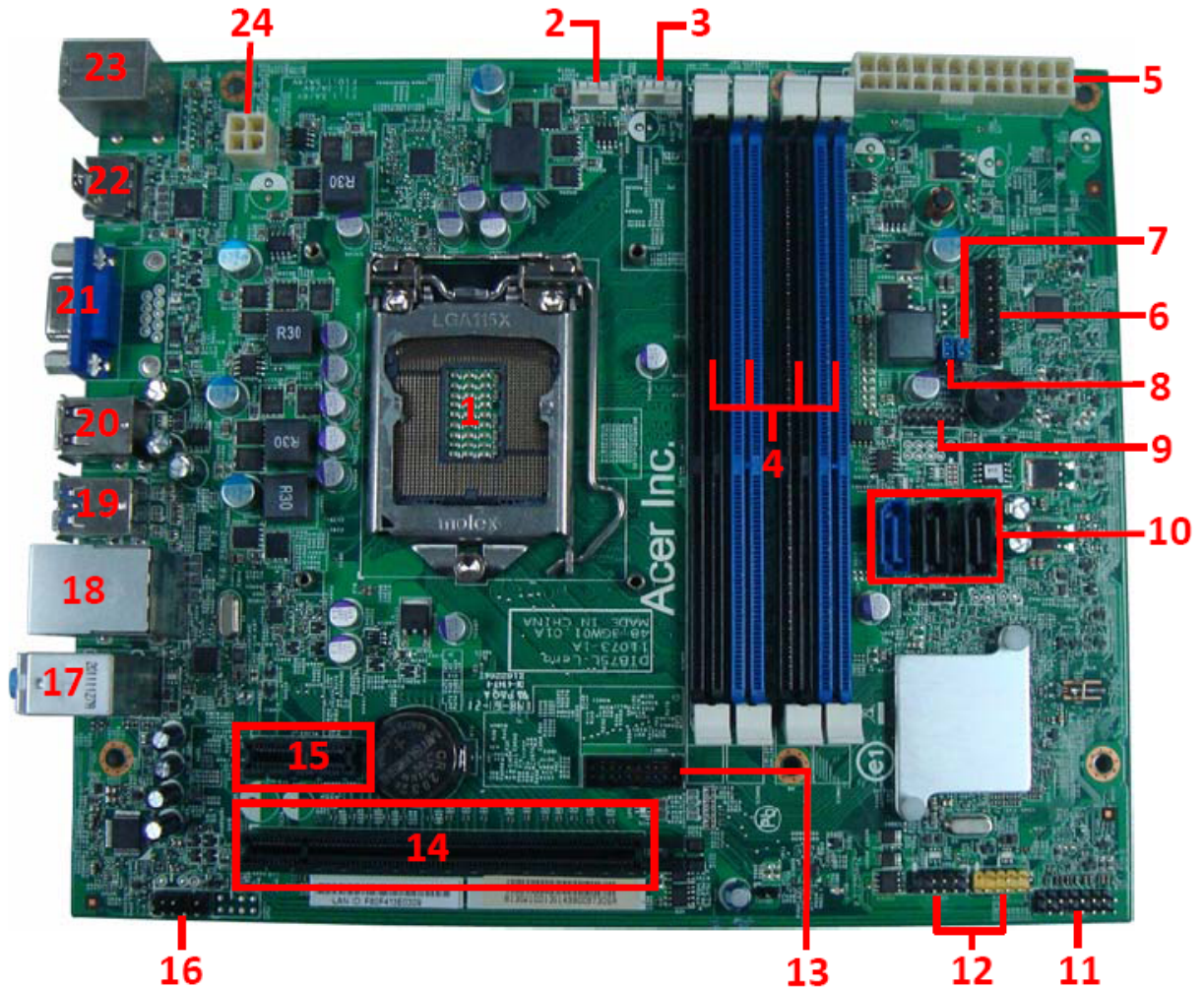

No	Label	Description	No	Label	Description
1	CPU socket	LGA1155 Pin socket for Intel IVY/SANDY BRIDGE CPUs	2	CFAN1	CPU cooling fan connector
3	SFAN1	System fan connector	4	DIMM1~4	240-pin DDR3 SDRAM slots
5	PWR1	Standard 24-pin ATX power connector	6	TPM1	TPM header
7	MECLR1	Clear ME jumper	8	CMOS1	Clear CMOS jumper

No	Label	Description	No	Label	Description
9	DBGH1	Debug header	10	SATA0~2	Serial ATA connectors
11	LEDH1	Front panel switch/ LED header	12	USBF3~4	Front panel USB headers
13	USBF1	Front panel USB3.0 headers	14	PCIE16	PCI Express x16 slot
15	PCIE1	PCI Express x1 slot	16	AUDF1	Front panel audio header
17	JK1	On board audio connector	18	ULAN1	On board USB LAN connector
19	USB30	On board USB3.0 connector	20	USB1	On board USB connector
21	VGA1	On board VGA connector	22	HDMI1	On board HDMI connector
23	KBMS1	On board KB/MS connector	24	PWR2	Auxiliary 4-pin power connector

Jumper Setting

This section explains how to set the jumper for correct configuration of the main board.

Jumpers with more than one pin are numbered. When setting a jumper, ensure that the jumper caps are placed on the correct pins.

The following illustration shows the location of CMOS1.

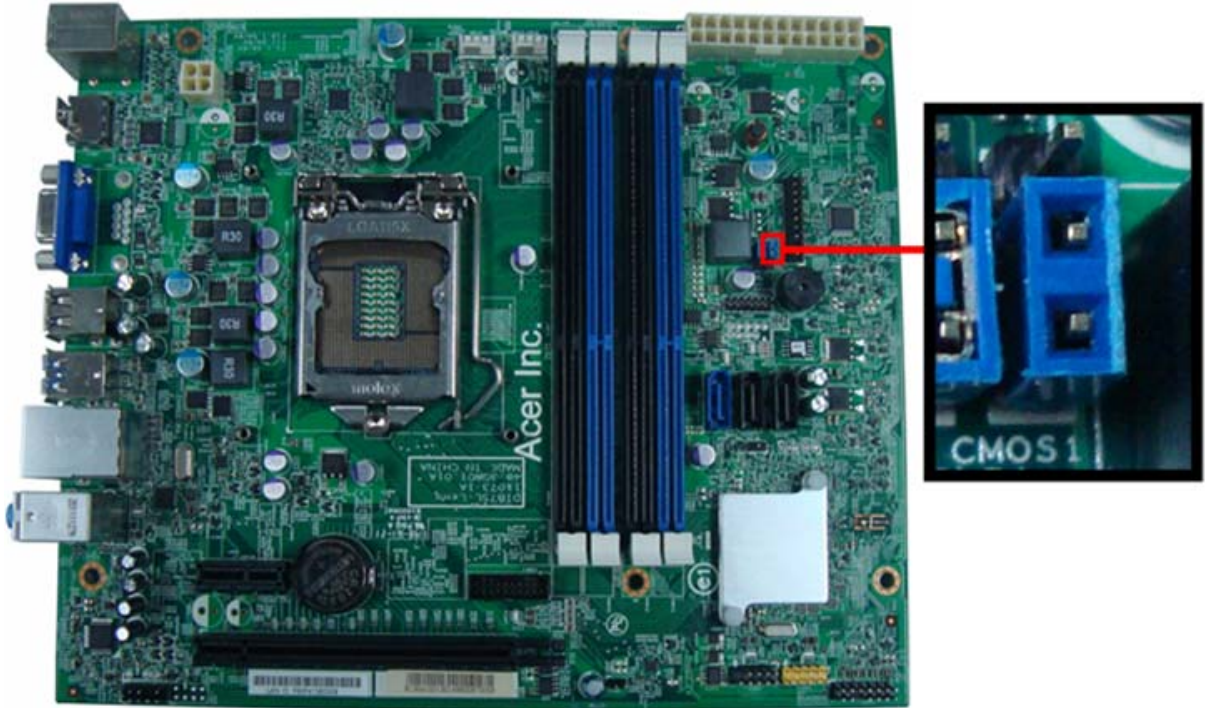

The following table shows the settings of the 3-pin SW1 jumper. Place the jumper cap on pins 1 and 2 to close or short the jumper. Place the jumper cap on pins 2 and 3 to open or clear CMOS.

Jumper	Type	Description	Setting (default)	
CMOS1	3-pin	Clear CMOS	1-2: Close (default) 2-3: Open Before clearing the CMOS, make sure to turn off the system.	 1 CLR_CMOS

Internal Header Pin Definition

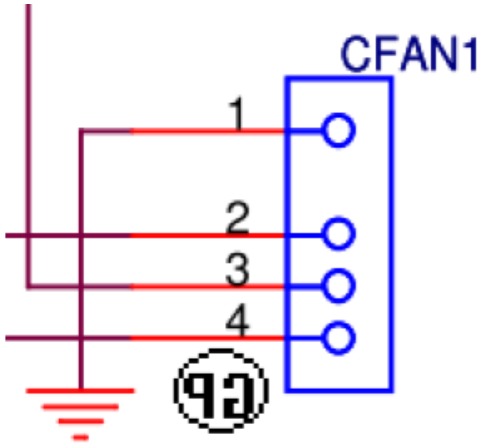
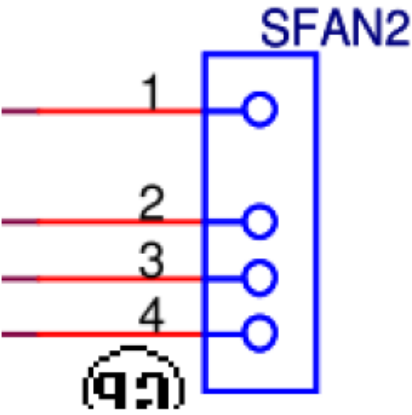
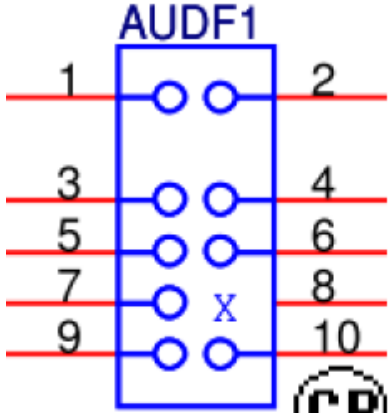
Header Name	Function	Definition
	CPU Fan Header	1:GND 2:+12V 3:SENSE 4:PWM CONTROL
	System Fan Header	1:GND 2:+12V 3:SENSE 4:PWM CONTROL
	Front Panel Audio Header	1:MIC_L 2:GND 3:MIC_R 4:PWR 5:FRONT_R 6:MIC_JD 7:FRONT_SENCE 8:NC 9:FRONT_L 10:FRONT_JD

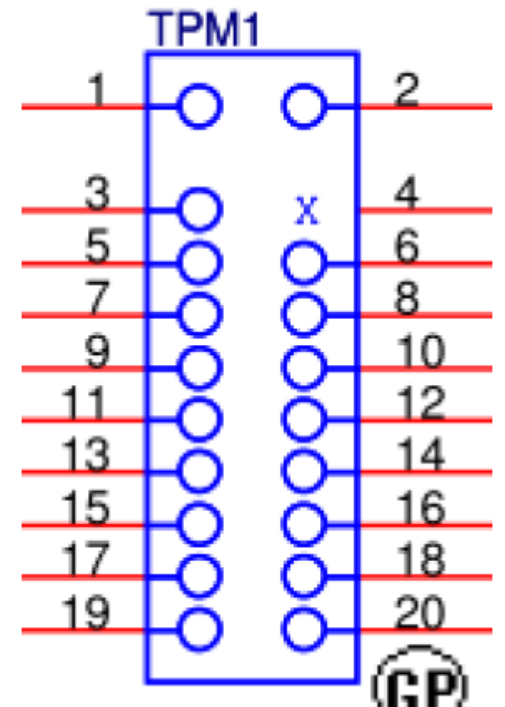
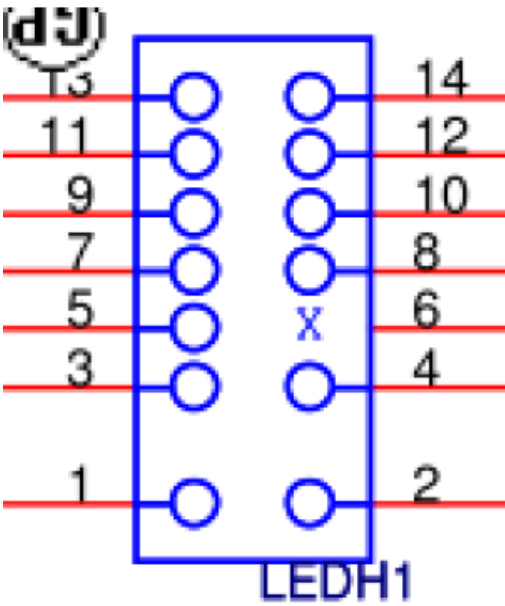
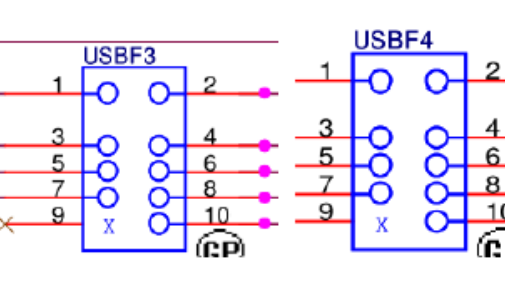
Header Name	Function	Definition
 <p>TPM1</p>	<p>TPM Header</p>	<p>1:CLOCK 2:GND 3:LFRAME 4:NC 5:RESET 6:NC 7:DATA 8:DATA 9:VCC3 10:DATA 11:DATA 12:GND 13:NC 14:NC 15:SB3V 16:SERIRQ 17:GND 18:CLOCK 19:VCC3 20:NC</p>
 <p>LEDH1</p>	<p>Front panel Header</p>	<p>1:NC 2:GND 3:SB5V 4:LAN LED 5:NC 6:NC 7:PWR RST CONTROL 8:GND 9:GND 10:PWR BTN CONTROL 11:SATA LED 12:GND 13:VCC 14:VCC5 for HDD LED</p>
 <p>USBF3 USBF4</p>	<p>Front USB Header</p>	<p>1:USB PWR 2:USB PWR 3:USB_N0 4:USB_N1 5:USB_P0 6:USB_P1 7/8:GND 9:NC 10:GND</p>

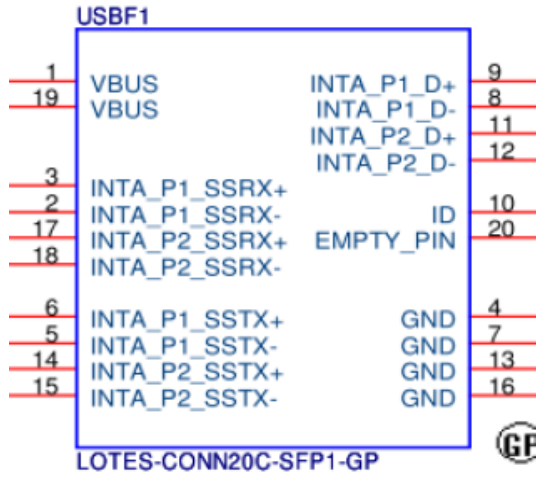
Header Name	Function	Definition
	<p>Front USB3.0 Header</p>	<p>1:USB PWR 2:RXN1 3:RXP1 4:GND 5:TXN1 6:TXP1 7:GND 8:USB_N1 9:USB_P1 10:OC 11:USB_P2 12:USB_N2 13:GND 14:TXP2 15:TXN2 16:GND 17:RXP2 18:RXN2 19:USB PWR 20:NC</p>

Connector Pin Definition

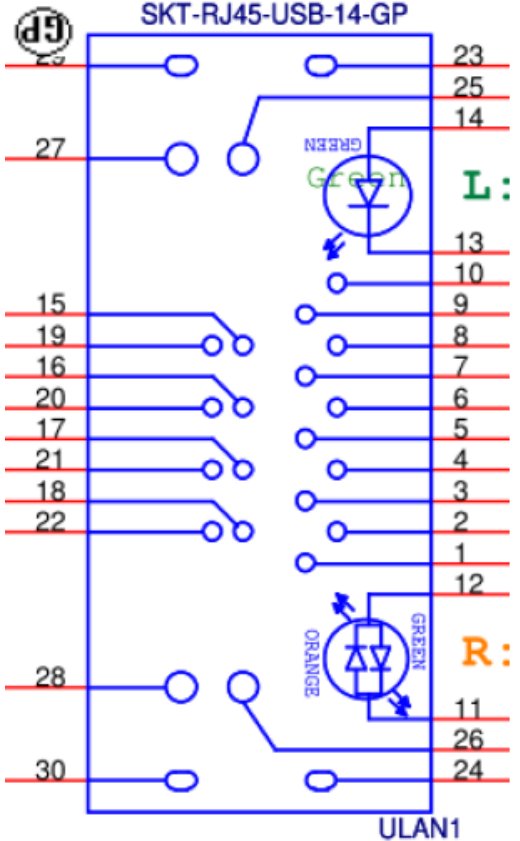
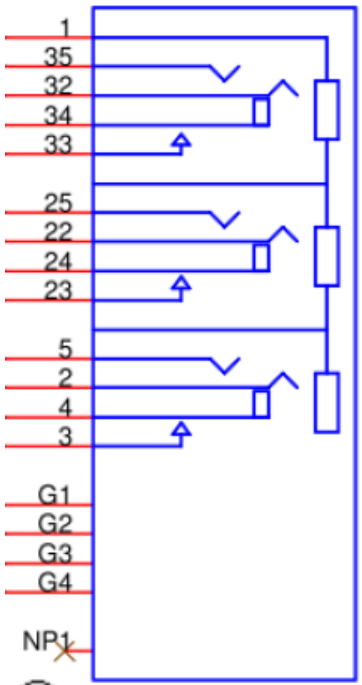
Header Name	Function	Definition
 <p>SKT-RJ45-USB-14-GP</p> <p>29-pin header (left): 27, 15, 19, 16, 20, 17, 21, 18, 22, 28, 30</p> <p>26-pin header (right): 23, 25, 14, 13, 10, 9, 8, 7, 6, 5, 4, 3, 2, 1, 12, 11, 26, 24</p> <p>Labels: GREEN, ORANGE, L:, R:, ULAN1</p>	<p>RJ45 and 2 PORT USB</p>	<p>1:LAN PWR 2:MDI0+ 3:MDI0- 4:MDI1+ 5:MDI1- 6:MDI2+ 7:MDI2- 8:MDI3+ 9:MDI3- 10:GND 11:LAN_ACT_LED- 12:LAN_ACT_LED+ 13:LINK_100_LEDJ 14:LINK_1000_LEDJ 15:USB PWR 16:USB_N1 17:USB_P1 18:GND 19:USB PWR 20:USB_N0 21:USB_P0 22~30:GND</p>
 <p>JK1</p> <p>35-pin header (left): 1, 35, 32, 34, 33, 25, 22, 24, 23, 5, 2, 4, 3, G1, G2, G3, G4, NP1</p> <p>35-pin header (right): 1, 2, 3, 4, 5, 22, 23, 24, 25, 32, 33, 34, 35</p> <p>Labels: G1, G2, G3, G4, NP1</p>	<p>ADUIO JACK</p>	<p>1:GND 2:MIC_R 3:GND 4:MIC_JD 5:MIC_L 22:LINE_IN_R 23:GND 24:LINE_IN_JD 25:LINE_IN_L 32:LINE_OUT_R 33:GND 34:LINE_OUT_JD 35:LINE_OUT_L G1~4:GND NP1:NC</p>

<p>USB30</p> <p>Pin 1: VBUS#1 Pin 10: VBUS#10 Pin 2: D-#2 Pin 11: D-#11 Pin 3: D+#3 Pin 12: D+#12 Pin 7: GND-DRAIN#7 Pin 16: GND-DRAIN#16</p> <p>Pin 5: STDA-SSR-#5 Pin 14: STDA-SSR-#14 Pin 6: STDA-SSR+#6 Pin 15: STDA-SSR+#15 Pin 8: STDA-SST-#8 Pin 17: STDA-SST-#17 Pin 9: STDA-SST+#9 Pin 18: STDA-SST+#18 Pin 4: GND Pin 13: GND Pin 19: GND Pin 20: GND Pin 21: GND Pin 22: GND</p>	<p>USB3.0 CONN</p>	<p>1:USB PWR 2:USB_N0 3:USB_P0 4:GND 5:RXN1 6:RXP1 7:GND 8:TXN1 9:TXP1- 10:USB PWR 11:USB_N1 12:USB_P1 13:GND 14:RXN2 15:RXP2 16:GND 17:TXN2 18:TXP2 19~22:GND</p>
<p>VGA1</p> <p>Pin 16: RED Pin 6: GREEN Pin 11: BLUE Pin 7: HSYNC Pin 12: VSYNC Pin 8: DDC_DATA Pin 13: DDC_CLK Pin 9: GND Pin 14: GND Pin 10: GND Pin 15: GND Pin 17: GND</p>	<p>D-SUB</p>	<p>1:RED 2:GREEN 3:BLUE 4:NC 5,6,7,8:GND 9:+5V_VGA 10:GND 11:NC 12:DDC_DATA 13:HSYNC 14:VSYNC 15:DDC_CLK 16:GND 17:GND</p>

	<p>USB CONN</p>	<p>1:USB PWR 2:USB_N0 3:USB_P0 4:GND 5:USB PWR 6:USB_N1 7:USB_P1 8~12:GND</p>
	<p>HDMI</p>	<p>1:HDMI_P0 2:GND 3:HDMI_N0 4:HDMI_P1 5:GND 6:HDMI_N1 7:HDMI_P2 8:GND 9:HDMI_N2 10:HDMI_CLK_P 11:GND 12:HDMI_CLK_N 13:NC 14:NC 15:CTRL_CLK 16:CTRL_DATA 17:GND 18:+5V_PWR 19:DDSP_HP 20,21,22,23:GND</p>
	<p>PS2 KB/MS</p>	<p>1:MS_DATA 2:NC 3:GND 4:KBMS_PWR 5:MS_CLK 6:NC 7/8:GND 9:KB_DATA 10:NC 11:GND 12:KBMS_PWR 13:KB_CLK 14:NC 15,16,17:GND</p>

FRU (Field Replaceable Unit) List

This chapter offers the FRU (Field Replaceable Unit) list in global configuration of the Aspire X1935 desktop computer. Refer to this chapter whenever ordering the parts to repair or for RMA (Return Merchandise Authorization).

NOTES:

- When ordering FRU parts, check the most up-to-date information available on your regional web or channel. For whatever reasons a part number is changed, it will NOT be noted on the printed Service Guide. For Acer authorized service providers, your Acer office may have a different part number code from those given in the FRU list of this printed Service Guide. You MUST use the local FRU list provided by your regional Acer office to order FRU parts for service.
- To scrap or to return the defective parts, follow the local government ordinance or regulations on how to dispose it properly, or follow the rules set by your regional Acer office on how to return it.
- This document will be updated as more information about the FRU list becomes available.



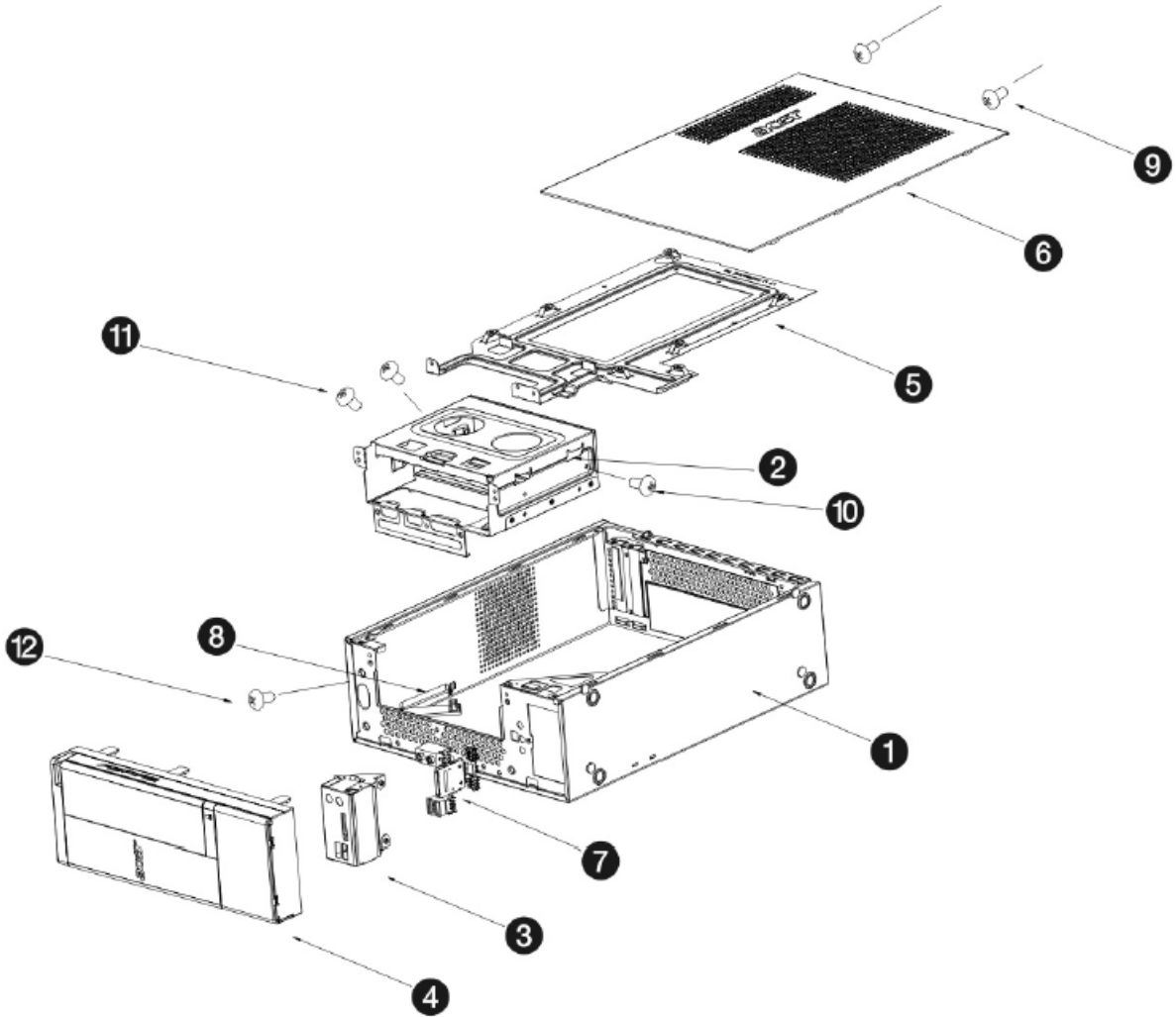

Aspire X1935 Exploded Diagram



NOTE: This section will be updated when more information becomes available.









ITEM	NAME	Q'TY	ITEM	NAME	Q'TY
1	Lowercase assembly	1	7	Front I/O and card reader board	1
2	HDD-ODD bracket	1	8	Plastic cable clip	1
3	Front I/O and card reader board bracket	1	9	Screw I #6-32 L5	2-4
4	Front cover assembly	1	10	Screw Pan, M3 L5	2
5	Lowercase support	1	11	Screw Flat #6-32*3/16 NI	4
6	Side cover	1	12	Screw Pan #6-32 L6 NI	13

Aspire X1935 FRU List

Category	Description	Part Number	Exploded Diagram Item
MB Kit			
	MB Kit aLena Intel B75 Acer Logo LF	MB.SJL01.001	N/A
Chassis			
	Hon Hai Chassis xSFF HX097I w/i FIO USB 2 port & 5-in-1 CR for Aspire AX152 Bezel, supports I/O shielding (2011 New CI)	HS.13100.267	N/A
	Hon Hai Chassis xSFF HX097J w/i FIO USB 2 port, w/o CR for Aspire AX153 Bezel, supports I/O shielding (2011 New CI)	HS.13100.268	
Bezel			
	Hon Hai Aspire Bezel AX152 w/ USB 2 port & 5-in-1 CR bezel (2011 New CI) w/HX097I chassis	PZ.11900.341	N/A
	Hon Hai Aspire Bezel AX153 w/ USB 2 port, w/o CR bezel (2011 New CI) w/HX097J chassis	PZ.11900.342	
CPU			
	Core i5-3450 (3.1G 6M 1333FSB)	KC.34501.CI5	N/A
	Core i3-2120 (3.30G 3M DDR3 1333) , Q0 , 65W , Intel HD Graphics 2000	KC.21201.CI3	
	Pentium Dual Core G630 (2.7G 3M 1066FSB)	KC.63001.DEG	
	CPU Intel Celeron G460 LGA 1.7G 1.5M 1066 1155 35W	KC.G0001.460	
Memory			
	GU502203EP0201 LF 128*8 0.065um	KN.1GB0H.015	N/A
	ACR128X64D3U1333C9 LF 128*8 0.07um	KN.1GB07.002	
	NT1GC64BH4B0PF-CG	KN.1GB03.035	
	HU524303EP0200	KN.2GB0H.012	
	NT2GC64B88B0NF-CG 256*8 50nm	KN.2GB03.026	
	ACR256X64D3U13C9G	KN.2GB07.007	
	NT4GC64B8HB0NF-CG	KN.4GB03.010	

Category	Description	Part Number	Exploded Diagram Item
	HU564403EP0200	KN.4GB0H.001	
	ACR512X64D3U13C9G	KN.4GB07.002	
	Memory A-DATA UNB-DIMM DDRIII 1333 2GB AD6311B0823EV LF+HF	KN.2GB0C.009	
	Memory A-DATA UNB-DIMM DDRIII 1333 4GB AD6311C1624EV LF+HF	KN.4GB0C.002	
HDD			
	"HDD SEAGATE 3.5" 7200rpm 500GB ST3500413AS(Pharaoh 6G) SATA III 16MB LF F/W:JC45"	KH.50001.022	N/A
	"HDD SEAGATE 3.5" 7200rpm 1000GB ST31000524AS (Pharaoh 6G) SATA III 32MB LF F/W:JC45 "	KH.01K01.016	
	HDD WD 3.5" 7200rpm 320GB WD3200AAKX-221CA1 XL500-1D SATA III 16MB LF F/W:17.01H17	KH.32008.025	
	HDD WD 3.5" 7200rpm 500GB WD5000AAKX-221CA1 XL500-1D SATA III 16MB LF F/W:17.01H17	KH.50008.025	
	HDD WD 3.5" 7200rpm 1000GB WD10EALX-229BA1 XL500-2 SATA III 32MB LF F/W:17.01H17	KH.01K08.014	
	HDD WD 3.5" 5400rpm 1000GB WD10EADX-22TDHB0 GP500 SATA III 32MB LF F/W:77.04D77	KH.01K08.013	
	HDD HGST 3.5" 7200rpm 1500GB HDS723015BLA642(Mariner) SATA III 64MB LF F/W:MNR580	KH.15K07.001	
	HDD HGST 3.5" 7200rpm 500GB HDS721050CLA662(Jupiter, 6G) SATA III 16MB LF F/W : JPT50E	KH.50007.014	
	HDD WD 3.5" 7200rpm 250GB WD2500AAKX-001CA0(XL500) SATA III 16MB LF F/W:15.01H15	KH.25008.032	
ODD			
	ODD HLDS DVD-ROM HH 16X DH40N LF+HF Black Bezel AC01 SATA (Win7)	KV.0160D.020	N/A
	ODD PLDS DVD-ROM HH 16X DH-16D6SH LF+HF Black Bezel SATA (Win7)	KV.0160F.006	
	ODD PIONEER DVD-ROM HH 16X DVR-231RS LF+HF Black Bezel SATA (Win7)	KV.01605.007	
	ODD HLDS Super-Multi DRIVE HH 16X GH70N LF+HF Black Bezel SATA (Win7)	KU.0160D.055	
	ODD PLDS Super-Multi DRIVE HH DL 16X DH-16ABSH LF Black Bezel (HF+Win7) SATA	KU.0160F.011	
	ODD PIONEER Super-Multi DRIVE HH DL 16X DVR-219RS LF Black Bezel SATA (Win7+HF)	KU.01605.007	
VGA			

Category	Description	Part Number	Exploded Diagram Item
	288-7N162-A01AC GT530 2GB 128bit DDR3 DVI + HDMI SAMSUNG LP	VG.PCPT5.302	N/A
	288-5N214-A10AC GT520 2GB 64bits sDDR3 DVI-I + HDMI LP MIRCON	VG.PCP52.202	
	288-1N222-A01AC 510 1GB DDR3 64bits DVII + HDMI Hynix LP	VG.PCPT5.102	
	288-7N122-A00AC 405 512MB 64bits DDR3 DVI-I + HDMI LP Micron	VG.PCPT4.B02	
	288-9E145-A01AC HD7450 2GB sDDR3 64bit DVI-I + HDMI AMD LP	VG.PCP74.702	
	288-AE180-A00AC HD7350 1GB DDR3 64bit DVI-I + HDMI AMD LP	VG.PCP73.502	
	HD7350 1GB DDR3 64bit DVI-I + HDMI AMD LP	VG.ECS73.502	
Wireless LAN Card			
	WN7601R, Ralink RT3090, 802.11b/g/n 1x1 WLAN PCI-E x1 card (Low-profile)	NI.10200.038	N/A
Power Supply			
	Non-PFC 220W (8.5L) EuP	PY.2200B.009	N/A
	Non-PFC 220W (8.5L) EuP	PY.22009.009	
	PFC 220W (8.5L) EuP	PY.2200B.010	
	PFC 220W (8.5L) EuP	PY.22009.010	
	FR 220W (8.5L) EuP 82+	PY.2200B.011	
	FR 220W (8.5L) EuP 82+	PY.22009.011	
	Non-PFC 220W (8.5L) EuP	PY.2200F.004	
	PFC 220W (8.5L) EuP	PY.2200F.005	
	FR 220W (8.5L) EuP 82+	PY.2200F.006	
Speaker			
	JS speaker USB MS1238UA with new acer logo	SP.10600.048	N/A
	JS speaker USB MS1238UA with new acer logo (meet AJC spec)	SP.10600.049	
	Neosonica speaker USB 9M-20A200-000 with new acer logo	SP.10600.051	
	Neosonica speaker USB 9M-20A200-000 with new acer logo (meet AJC Spec.)	SP.10600.052	

Category	Description	Part Number	Exploded Diagram Item
Mouse			
	Lite-on mouse USB SM-9020B black;with new acer logo	MS.11200.123	N/A
	Primax mouse USB MOF9UO black color;with new acer logo	MS.11200.115	
	Primax Optical mouse PS2 MOFGKO with acer logo	MS.11200.105	
	Logitech Optical mouse PS2 M-S0004-O with acer logo	MS.11200.104	
Optional Accessories			
	PC Partner DVI to DSUB converter	D0.VGA26.P01	
Keyboard			
	Keyboard LITE-ON SK-9621B USB Black US	KB.USB0B.448	N/A
	Keyboard LITE-ON SK-9621B USB Black Traditional Chinese	KB.USB0B.449	
	Keyboard LITE-ON SK-9621B USB Black Simplified Chinese	KB.USB0B.450	
	Keyboard LITE-ON SK-9621B USB Black US International	KB.USB0B.451	
	Keyboard LITE-ON SK-9621B USB Black Arabic/English	KB.USB0B.452	
	Keyboard LITE-ON SK-9621B USB Black Thailand	KB.USB0B.453	
	Keyboard LITE-ON SK-9621B USB Black Spanish	KB.USB0B.454	
	Keyboard LITE-ON SK-9621B USB Black Portuguese	KB.USB0B.455	
	Keyboard LITE-ON SK-9621B USB Black Canadian French	KB.USB0B.456	
	Keyboard LITE-ON SK-9621B USB Black Brazilian Portuguese	KB.USB0B.457	
	Keyboard LITE-ON SK-9621B USB Black Japanese	KB.USB0B.458	
	Keyboard LITE-ON SK-9621B USB Black German	KB.USB0B.459	
	Keyboard LITE-ON SK-9621B USB Black Italian	KB.USB0B.460	
	Keyboard LITE-ON SK-9621B USB Black French	KB.USB0B.461	
	Keyboard LITE-ON SK-9621B USB Black Swedish	KB.USB0B.462	
	Keyboard LITE-ON SK-9621B USB Black UK	KB.USB0B.463	
	Keyboard LITE-ON SK-9621B USB Black Dutch	KB.USB0B.464	
	Keyboard LITE-ON SK-9621B USB Black Swiss/G	KB.USB0B.465	
	Keyboard LITE-ON SK-9621B USB Black Belgium	KB.USB0B.466	
Keyboard LITE-ON SK-9621B USB Black Icelandic	KB.USB0B.467		

Category	Description	Part Number	Exploded Diagram Item
	Keyboard LITE-ON SK-9621B USB Black Norwegian	KB.USB0B.468	
	Keyboard LITE-ON SK-9621B USB Black Hebrew	KB.USB0B.469	
	Keyboard LITE-ON SK-9621B USB Black Polish	KB.USB0B.470	
	Keyboard LITE-ON SK-9621B USB Black Slovenian	KB.USB0B.471	
	Keyboard LITE-ON SK-9621B USB Black Slovak	KB.USB0B.472	
	Keyboard LITE-ON SK-9621B USB Black Russian	KB.USB0B.473	
	Keyboard LITE-ON SK-9621B USB Black Hungarian	KB.USB0B.474	
	Keyboard LITE-ON SK-9621B USB Black Greek	KB.USB0B.475	
	Keyboard LITE-ON SK-9621B USB Black Danish	KB.USB0B.476	
	Keyboard LITE-ON SK-9621B USB Black Czech	KB.USB0B.477	
	Keyboard LITE-ON SK-9621B USB Black Romanian	KB.USB0B.478	
	Keyboard LITE-ON SK-9621B USB Black Turkish	KB.USB0B.479	
	Keyboard LITE-ON SK-9621B USB Black Turkish-Q	KB.USB0B.480	
	Keyboard LITE-ON SK-9621B USB Black Arabic/French	KB.USB0B.481	
	Keyboard LITE-ON SK-9621B USB Black Kazakh	KB.USB0B.482	
	Keyboard LITE-ON SK-9621B USB Black Turkmen	KB.USB0B.483	
	Keyboard LITE-ON SK-9621B USB Black Nordic	KB.USB0B.484	
	Keyboard LITE-ON SK-9621B USB Black English/Canadian French	KB.USB0B.485	
	Keyboard LITE-ON SK-9621B USB Black Czech/Slovak	KB.USB0B.486	
	Keyboard LITE-ON SK-9621B USB Black Swiss/FR	KB.USB0B.487	
	Keyboard LITE-ON SK-9621B USB Black Korean	KB.USB0B.488	
	Keyboard LITE-ON SK-9621B USB Black Spanish Latin	KB.USB0B.489	
	Keyboard LITE-ON SK-9611 PS/2 Black US	KB.PS20B.157	
	Keyboard LITE-ON SK-9611 PS/2 Black Traditional Chinese	KB.PS20B.158	
	Keyboard LITE-ON SK-9611 PS/2 Black Simplified Chinese	KB.PS20B.159	
	Keyboard LITE-ON SK-9611 PS/2 Black US International	KB.PS20B.160	
	Keyboard LITE-ON SK-9611 PS/2 Black Arabic/English	KB.PS20B.161	

Category	Description	Part Number	Exploded Diagram Item
	Keyboard LITE-ON SK-9611 PS/2 Black Thailand	KB.PS20B.162	
	Keyboard LITE-ON SK-9611 PS/2 Black Spanish	KB.PS20B.163	
	Keyboard LITE-ON SK-9611 PS/2 Black Portuguese	KB.PS20B.164	
	Keyboard LITE-ON SK-9611 PS/2 Black Canadian French	KB.PS20B.165	
	Keyboard LITE-ON SK-9611 PS/2 Black Brazilian Portuguese	KB.PS20B.166	
	Keyboard LITE-ON SK-9611 PS/2 Black Japanese	KB.PS20B.167	
	Keyboard LITE-ON SK-9611 PS/2 Black German	KB.PS20B.168	
	Keyboard LITE-ON SK-9611 PS/2 Black Italian	KB.PS20B.169	
	Keyboard LITE-ON SK-9611 PS/2 Black French	KB.PS20B.170	
	Keyboard LITE-ON SK-9611 PS/2 Black Swedish	KB.PS20B.171	
	Keyboard LITE-ON SK-9611 PS/2 Black UK	KB.PS20B.172	
	Keyboard LITE-ON SK-9611 PS/2 Black Dutch	KB.PS20B.173	
	Keyboard LITE-ON SK-9611 PS/2 Black Swiss/G	KB.PS20B.174	
	Keyboard LITE-ON SK-9611 PS/2 Black Belgium	KB.PS20B.175	
	Keyboard LITE-ON SK-9611 PS/2 Black Icelandic	KB.PS20B.176	
	Keyboard LITE-ON SK-9611 PS/2 Black Norwegian	KB.PS20B.177	
	Keyboard LITE-ON SK-9611 PS/2 Black Hebrew	KB.PS20B.178	
	Keyboard LITE-ON SK-9611 PS/2 Black Polish	KB.PS20B.179	
	Keyboard LITE-ON SK-9611 PS/2 Black Slovenian	KB.PS20B.180	
	Keyboard LITE-ON SK-9611 PS/2 Black Slovak	KB.PS20B.181	
	Keyboard LITE-ON SK-9611 PS/2 Black Russian	KB.PS20B.182	
	Keyboard LITE-ON SK-9611 PS/2 Black Hungarian	KB.PS20B.183	
	Keyboard LITE-ON SK-9611 PS/2 Black Greek	KB.PS20B.184	
	Keyboard LITE-ON SK-9611 PS/2 Black Danish	KB.PS20B.185	
	Keyboard LITE-ON SK-9611 PS/2 Black Czech	KB.PS20B.186	
	Keyboard LITE-ON SK-9611 PS/2 Black Romanian	KB.PS20B.187	
	Keyboard LITE-ON SK-9611 PS/2 Black Turkish	KB.PS20B.188	
	Keyboard LITE-ON SK-9611 PS/2 Black Turkish-Q	KB.PS20B.189	
	Keyboard LITE-ON SK-9611 PS/2 Black Arabic/French	KB.PS20B.190	
	Keyboard LITE-ON SK-9611 PS/2 Black Kazakh	KB.PS20B.191	
	Keyboard LITE-ON SK-9611 PS/2 Black Turkmen	KB.PS20B.192	

Category	Description	Part Number	Exploded Diagram Item
	Keyboard LITE-ON SK-9611 PS/2 Black Nordic	KB.PS20B.193	
	Keyboard LITE-ON SK-9611 PS/2 Black English/ Canadian French	KB.PS20B.194	
	Keyboard LITE-ON SK-9611 PS/2 Black Czech/ Slovak	KB.PS20B.195	
	Keyboard LITE-ON SK-9611 PS/2 Black Swiss/FR	KB.PS20B.196	
	Keyboard LITE-ON SK-9611 PS/2 Black Korean	KB.PS20B.197	
	Keyboard LITE-ON SK-9611 PS/2 Black Spanish Latin	KB.PS20B.198	
	Keyboard PRIMAX KB36111 PS/2 Black US	KB.PS20P.204	
	Keyboard PRIMAX KB36111 PS/2 Black Traditional Chinese	KB.PS20P.205	
	Keyboard PRIMAX KB36111 PS/2 Black Simplified Chinese	KB.PS20P.206	
	Keyboard PRIMAX KB36111 PS/2 Black US International	KB.PS20P.207	
	Keyboard PRIMAX KB36111 PS/2 Black Arabic/ English	KB.PS20P.208	
	Keyboard PRIMAX KB36111 PS/2 Black Thailand	KB.PS20P.209	
	Keyboard PRIMAX KB36111 PS/2 Black Spanish	KB.PS20P.210	
	Keyboard PRIMAX KB36111 PS/2 Black Portuguese	KB.PS20P.211	
	Keyboard PRIMAX KB36111 PS/2 Black Canadian French	KB.PS20P.212	
	Keyboard PRIMAX KB36111 PS/2 Black Brazilian Portuguese	KB.PS20P.213	
	Keyboard PRIMAX KB36111 PS/2 Black Japanese	KB.PS20P.214	
	Keyboard PRIMAX KB36111 PS/2 Black German	KB.PS20P.215	
	Keyboard PRIMAX KB36111 PS/2 Black Italian	KB.PS20P.216	
	Keyboard PRIMAX KB36111 PS/2 Black French	KB.PS20P.217	
	Keyboard PRIMAX KB36111 PS/2 Black Swedish	KB.PS20P.218	
	Keyboard PRIMAX KB36111 PS/2 Black UK	KB.PS20P.219	
	Keyboard PRIMAX KB36111 PS/2 Black Dutch	KB.PS20P.220	
	Keyboard PRIMAX KB36111 PS/2 Black Swiss/G	KB.PS20P.221	
	Keyboard PRIMAX KB36111 PS/2 Black Belgium	KB.PS20P.222	
	Keyboard PRIMAX KB36111 PS/2 Black Icelandic	KB.PS20P.223	
	Keyboard PRIMAX KB36111 PS/2 Black Norwegian	KB.PS20P.224	
	Keyboard PRIMAX KB36111 PS/2 Black Hebrew	KB.PS20P.225	
	Keyboard PRIMAX KB36111 PS/2 Black Polish	KB.PS20P.226	

Category	Description	Part Number	Exploded Diagram Item
	Keyboard PRIMAX KB36111 PS/2 Black Slovenian	KB.PS20P.227	
	Keyboard PRIMAX KB36111 PS/2 Black Slovak	KB.PS20P.228	
	Keyboard PRIMAX KB36111 PS/2 Black Russian	KB.PS20P.229	
	Keyboard PRIMAX KB36111 PS/2 Black Hungarian	KB.PS20P.230	
	Keyboard PRIMAX KB36111 PS/2 Black Greek	KB.PS20P.231	
	Keyboard PRIMAX KB36111 PS/2 Black Danish	KB.PS20P.232	
	Keyboard PRIMAX KB36111 PS/2 Black Czech	KB.PS20P.233	
	Keyboard PRIMAX KB36111 PS/2 Black Romanian	KB.PS20P.234	
	Keyboard PRIMAX KB36111 PS/2 Black Turkish	KB.PS20P.235	
	Keyboard PRIMAX KB36111 PS/2 Black Turkish-Q	KB.PS20P.236	
	Keyboard PRIMAX KB36111 PS/2 Black Arabic/French	KB.PS20P.237	
	Keyboard PRIMAX KB36111 PS/2 Black Kazakh	KB.PS20P.238	
	Keyboard PRIMAX KB36111 PS/2 Black Turkmen	KB.PS20P.239	
	Keyboard PRIMAX KB36111 PS/2 Black Nordic	KB.PS20P.240	
	Keyboard PRIMAX KB36111 PS/2 Black English/Canadian French	KB.PS20P.241	
	Keyboard PRIMAX KB36111 PS/2 Black Czech/Slovak	KB.PS20P.242	
	Keyboard PRIMAX KB36111 PS/2 Black Swiss/FR	KB.PS20P.243	
	Keyboard PRIMAX KB36111 PS/2 Black Korean	KB.PS20P.244	
	Keyboard PRIMAX KB36111 PS/2 Black Spanish Latin	KB.PS20P.245	
	Keyboard PRIMAX KB36111 PS/2 Black US with India Rupee Symbol	KB.PS20P.290	
	Keyboard PRIMAX KB36211 USB Black US	KB.USB0P.217	
	Keyboard PRIMAX KB36211 USB Black Traditional Chinese	KB.USB0P.218	
	Keyboard PRIMAX KB36211 USB Black Simplified Chinese	KB.USB0P.219	
	Keyboard PRIMAX KB36211 USB Black US International	KB.USB0P.220	
	Keyboard PRIMAX KB36211 USB Black Arabic/English	KB.USB0P.221	
	Keyboard PRIMAX KB36211 USB Black Thailand	KB.USB0P.222	
	Keyboard PRIMAX KB36211 USB Black Spanish	KB.USB0P.223	
	Keyboard PRIMAX KB36211 USB Black Portuguese	KB.USB0P.224	

Category	Description	Part Number	Exploded Diagram Item
	Keyboard PRIMAX KB36211 USB Black Canadian French	KB.USB0P.225	
	Keyboard PRIMAX KB36211 USB Black Brazilian Portuguese	KB.USB0P.226	
	Keyboard PRIMAX KB36211 USB Black Japanese	KB.USB0P.227	
	Keyboard PRIMAX KB36211 USB Black German	KB.USB0P.228	
	Keyboard PRIMAX KB36211 USB Black Italian	KB.USB0P.229	
	Keyboard PRIMAX KB36211 USB Black French	KB.USB0P.230	
	Keyboard PRIMAX KB36211 USB Black Swedish	KB.USB0P.231	
	Keyboard PRIMAX KB36211 USB Black UK	KB.USB0P.232	
	Keyboard PRIMAX KB36211 USB Black Dutch	KB.USB0P.233	
	Keyboard PRIMAX KB36211 USB Black Swiss/G	KB.USB0P.234	
	Keyboard PRIMAX KB36211 USB Black Belgium	KB.USB0P.235	
	Keyboard PRIMAX KB36211 USB Black Icelandic	KB.USB0P.236	
	Keyboard PRIMAX KB36211 USB Black Norwegian	KB.USB0P.237	
	Keyboard PRIMAX KB36211 USB Black Hebrew	KB.USB0P.238	
	Keyboard PRIMAX KB36211 USB Black Polish	KB.USB0P.239	
	Keyboard PRIMAX KB36211 USB Black Slovenian	KB.USB0P.240	
	Keyboard PRIMAX KB36211 USB Black Slovak	KB.USB0P.241	
	Keyboard PRIMAX KB36211 USB Black Russian	KB.USB0P.242	
	Keyboard PRIMAX KB36211 USB Black Hungarian	KB.USB0P.243	
	Keyboard PRIMAX KB36211 USB Black Greek	KB.USB0P.244	
	Keyboard PRIMAX KB36211 USB Black Danish	KB.USB0P.245	
	Keyboard PRIMAX KB36211 USB Black Czech	KB.USB0P.246	
	Keyboard PRIMAX KB36211 USB Black Romanian	KB.USB0P.247	
	Keyboard PRIMAX KB36211 USB Black Turkish	KB.USB0P.248	
	Keyboard PRIMAX KB36211 USB Black Turkish-Q	KB.USB0P.249	
	Keyboard PRIMAX KB36211 USB Black Arabic/French	KB.USB0P.250	
	Keyboard PRIMAX KB36211 USB Black Kazakh	KB.USB0P.251	
	Keyboard PRIMAX KB36211 USB Black Turkmen	KB.USB0P.252	
	Keyboard PRIMAX KB36211 USB Black Nordic	KB.USB0P.253	
	Keyboard PRIMAX KB36211 USB Black English/Canadian French	KB.USB0P.254	
	Keyboard PRIMAX KB36211 USB Black Czech/Slovak	KB.USB0P.255	

Category	Description	Part Number	Exploded Diagram Item
	Keyboard PRIMAX KB36211 USB Black Swiss/FR	KB.USB0P.256	
	Keyboard PRIMAX KB36211 USB Black Korean	KB.USB0P.257	
	Keyboard PRIMAX KB36211 USB Black Spanish Latin	KB.USB0P.258	
	Keyboard PRIMAX KB36211 USB Black US with India Rupee Symbol	KB.USB0P.306	